

GLÁUCIA LOMBARDI

# A Praia

Brincando com dobradura

5ª Edição

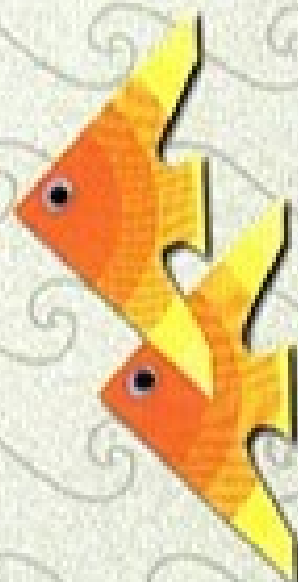
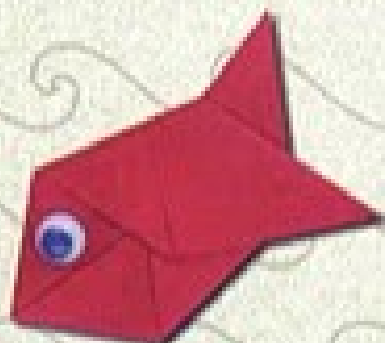
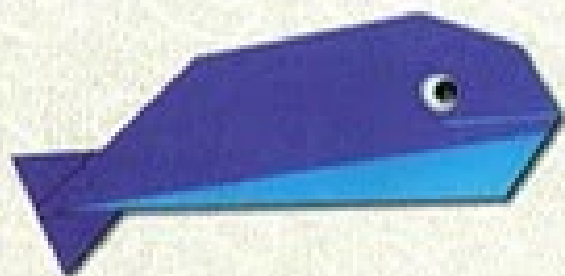

# A PRAIA

## O SORVETE E A PIPA

Use um papel quadrado medindo 10 x 10 cm.

Acompanhe a história e preste atenção aos movimentos correspondentes.

Peguei um papel quadrado, dobrei-o ao meio, transformando-o em um chapéu triangular.

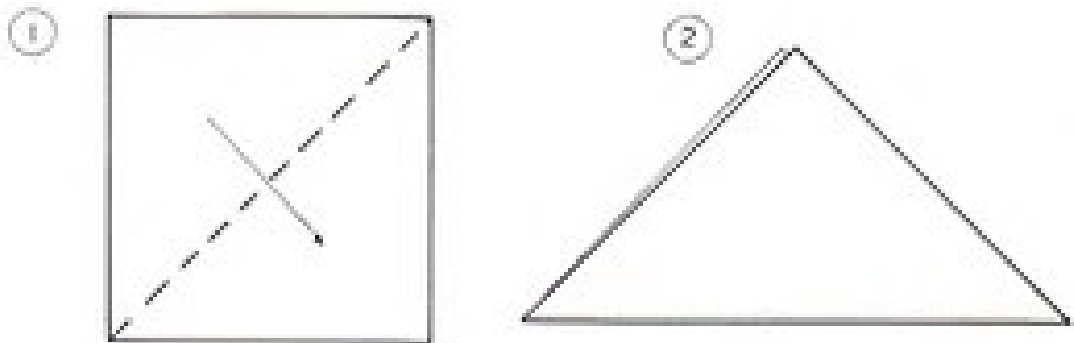

Estava muito calor e eu usei o papel para me abanar. Fui tomar sorvete de casquinha.

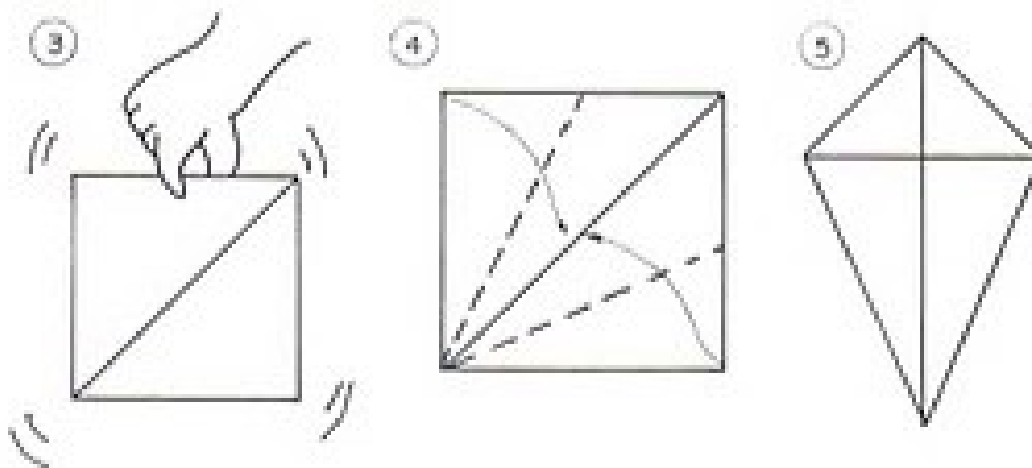

Para o sorvete ficar mais gostoso, a parte de cima dele pode ser recortada. Você também pode fazer uma colagem com algodão e papel colorido.

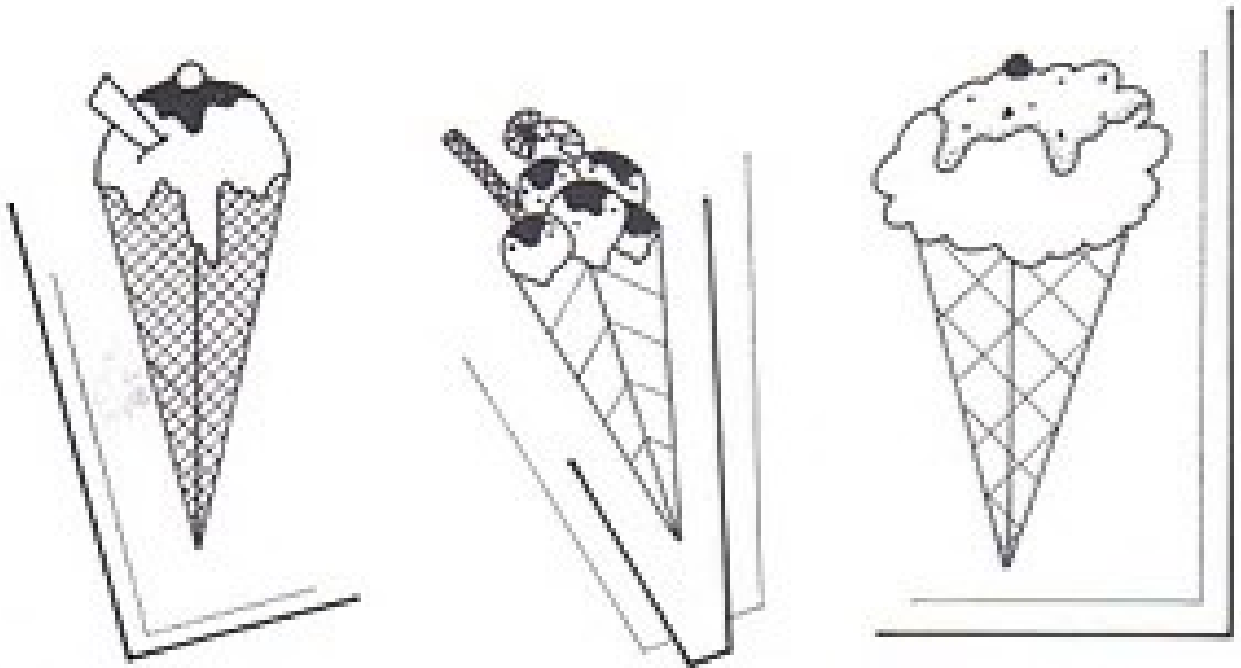

Quando virei o sorvete ele se transformou em uma pipa.  
Fui seguindo a pipa que rodopiava no ar, até que cheguei a uma praia.

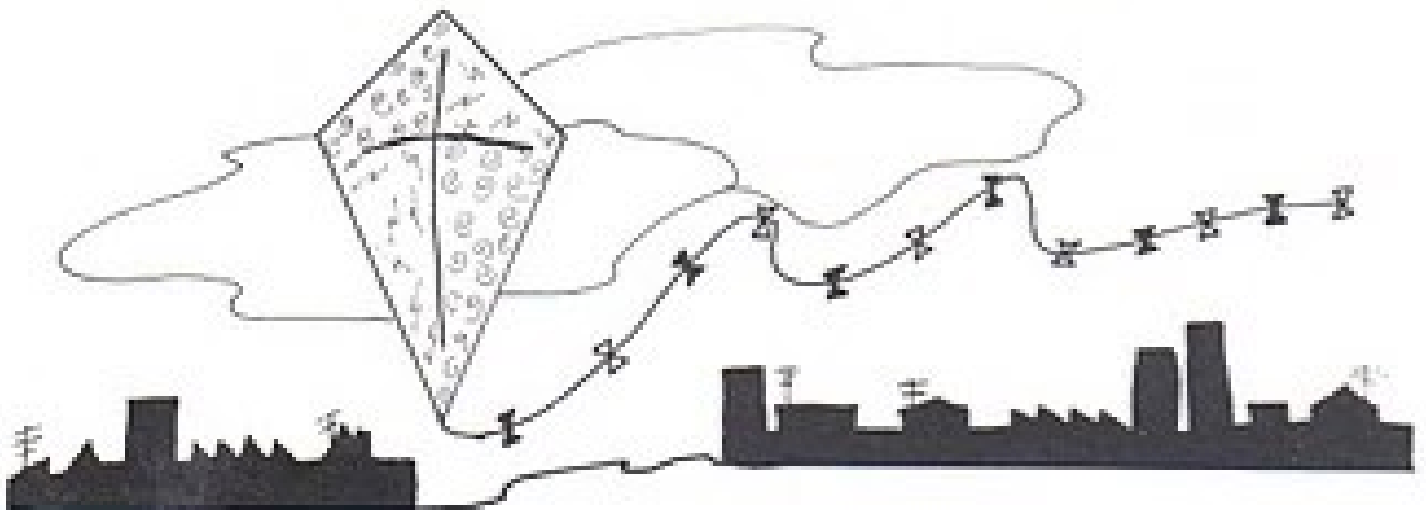

E que bela vista eu encontrei:

- alguns barquinhos navegando
- um caranguejo solitário andando sobre a areia
- crianças brincando de vôlei e calaques
- muitos peixinhos coloridos
- uma gaivota voando perto do mar
- uma baleia e um tubarão
- uma tartaruga marinha põdo seus ovos na areia
- e os turistas se divertindo debaixo do guarda-sol.

# O BARCO

Use um papel quadrado medindo 10 x 10 cm.

Peguei um chapéu e fui passear na praia.

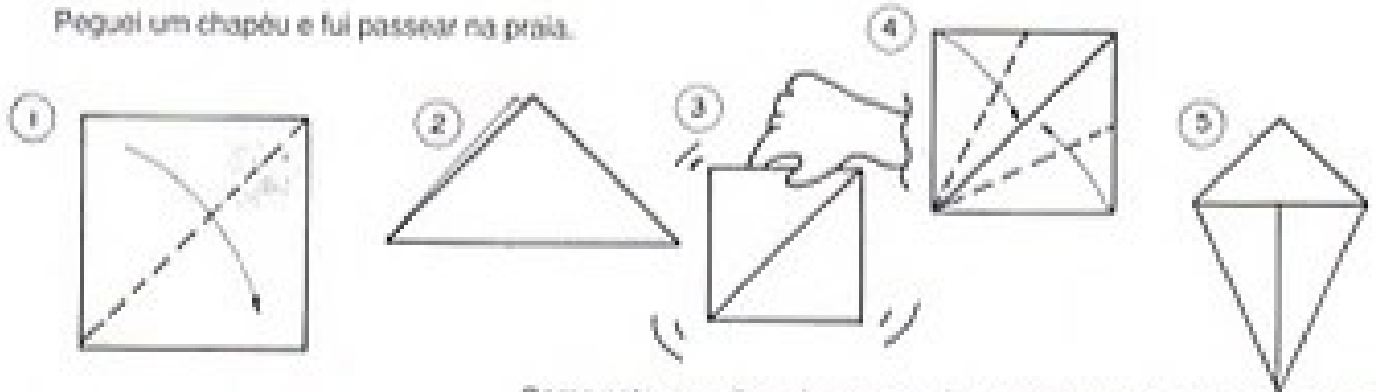

Como estava muito calor, comecei a me abanar e fui tomar um sorvete.

Por causa do calor, a copa do meu sorvete derreteu inteirinha.

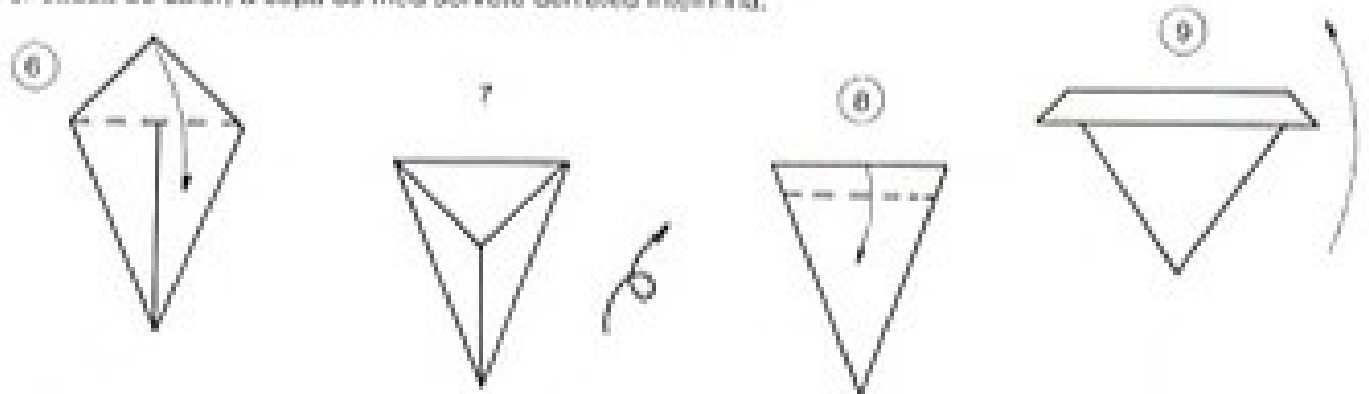

Eu virei o sorvete, mas ele continuou derretendo.

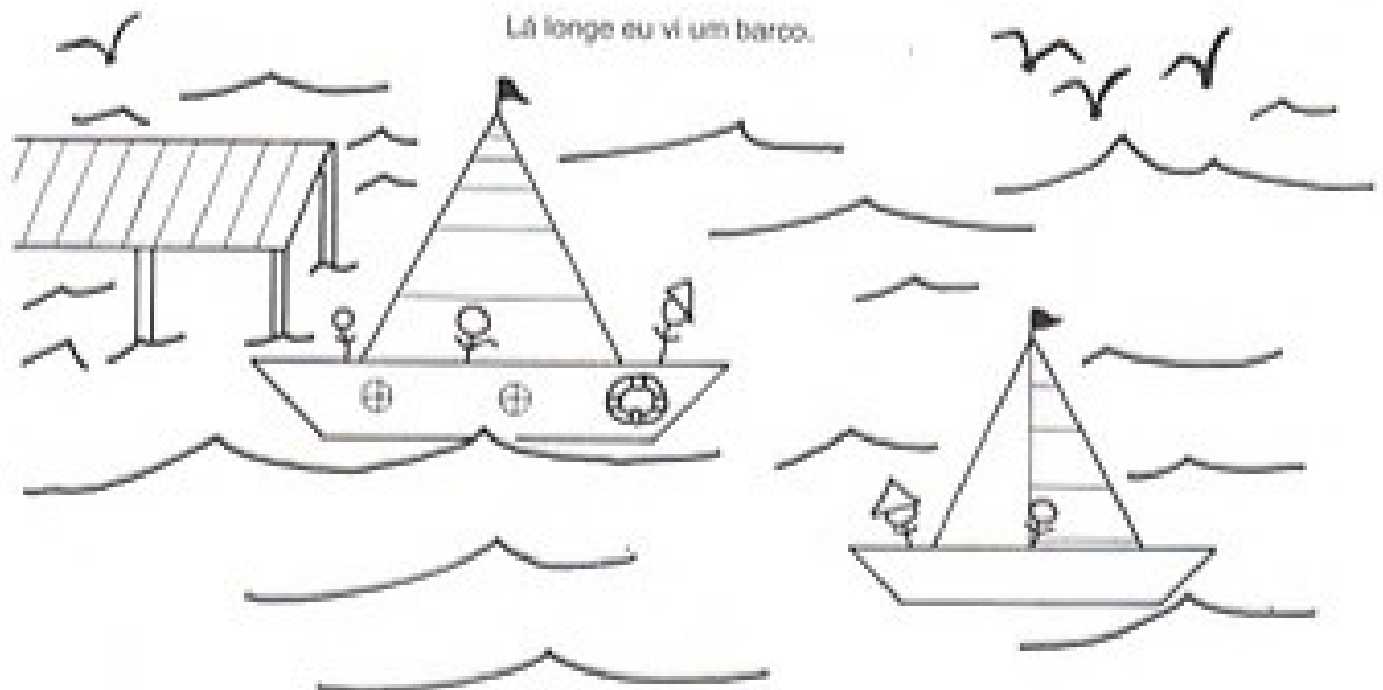

# O CARANGUEJO

Use dois quadrados de papel espelho medindo 10 x 10 cm.  
Dobre os dois quadrados da mesma maneira, seguindo as instruções de 1 a 8.

Peguei o meu chapéu e fui tomar sorvete na praia.

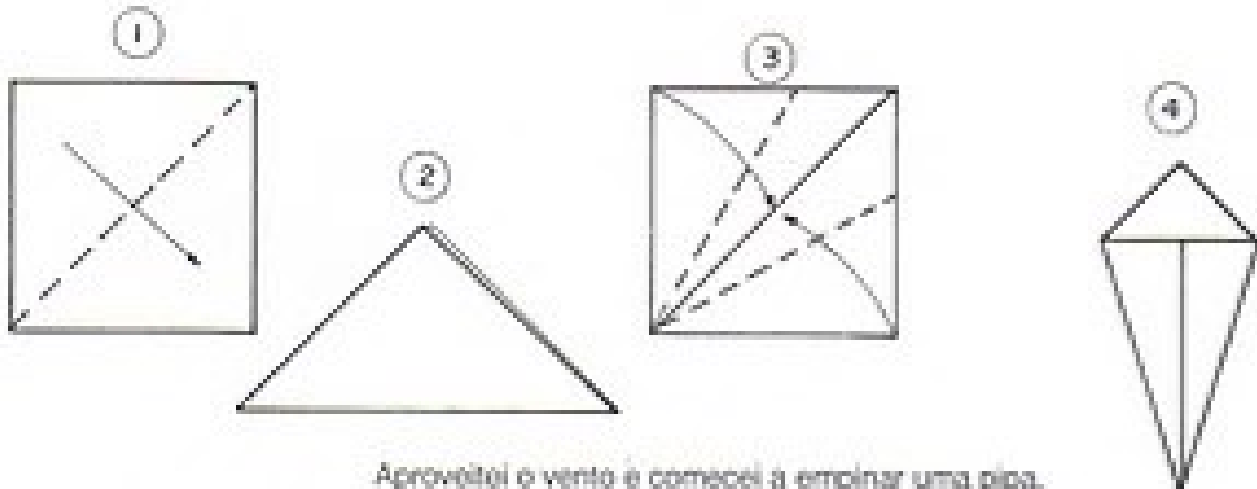

Aproveitei o vento e comecei a empinar uma pipa.

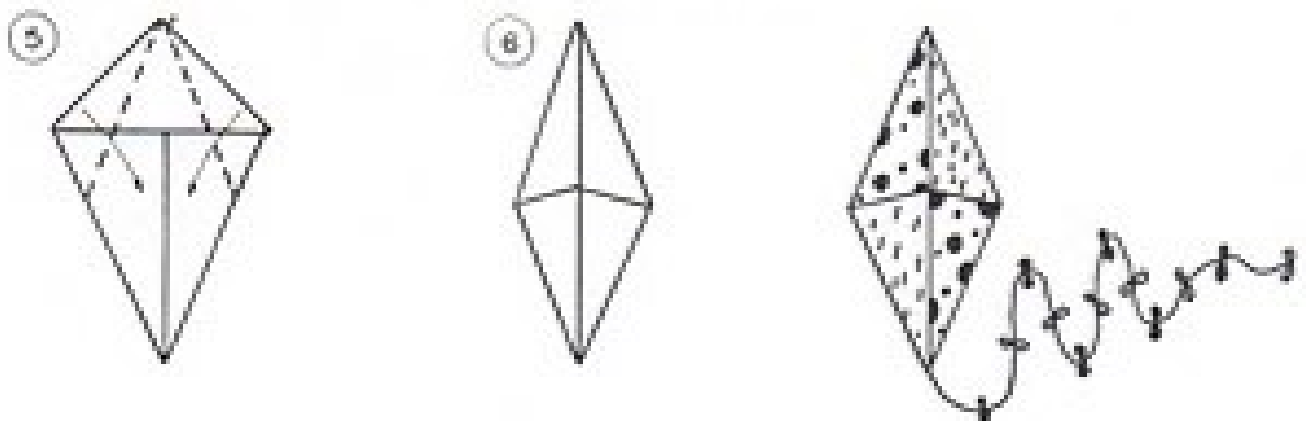

Ela voou e se enroscou em uma árvore. Eu puxei a linha e a pipa dobrou ao meio.



9 A

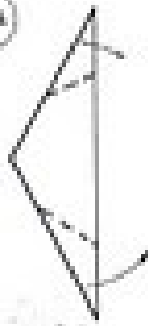

9 B



10 A

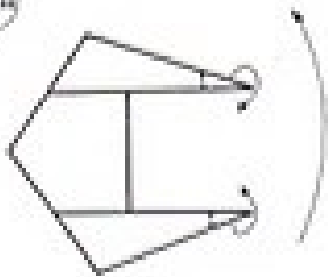

10 B

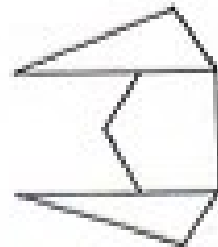

11 A

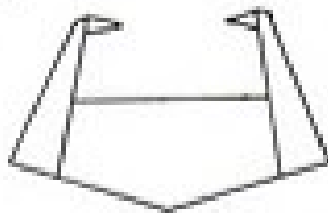

11 B

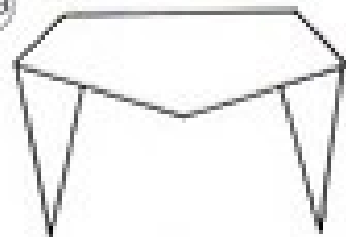

Coloque a figura A sobre a figura B.

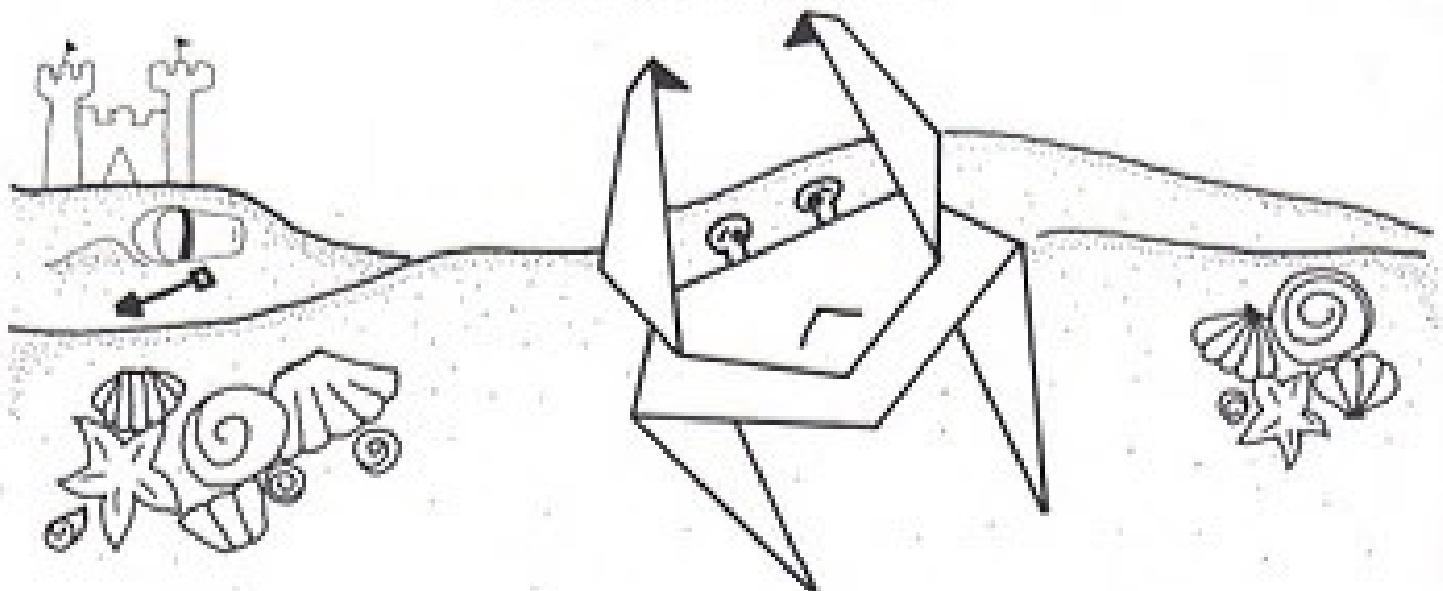

# O VELEIRO E O CAIAQUE

Use dois quadrados de papel espelho medindo 10 x 10 cm.

Em um dos quadrados, repita os passos de 1 a 6 do caranguejo.

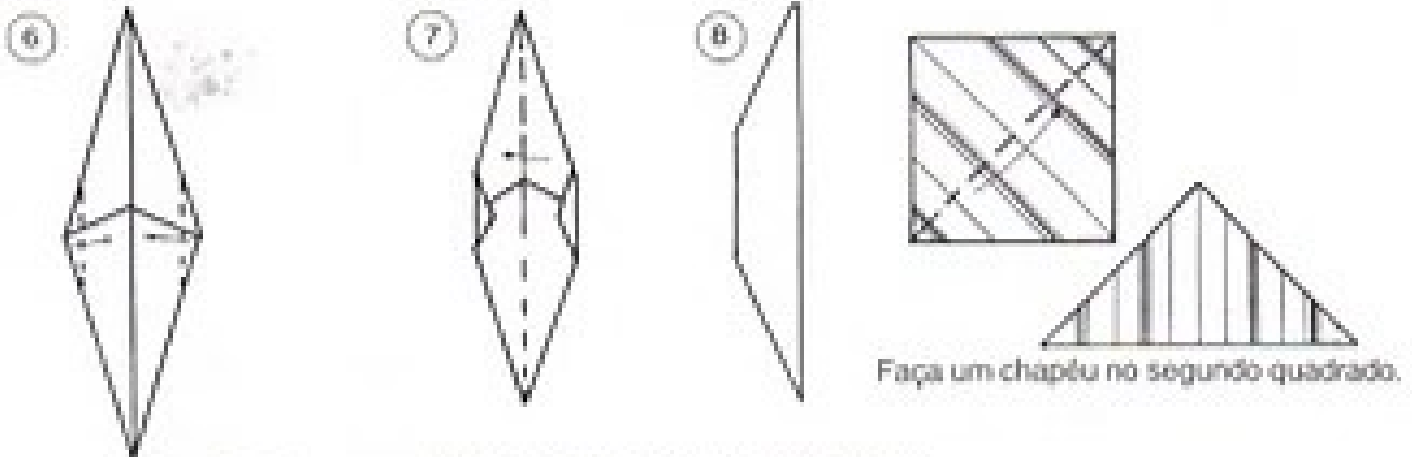

Junte as figuras para formar o veleiro.



Use apenas a parte de baixo do veleiro para fazer um caiaque ou uma canoa.

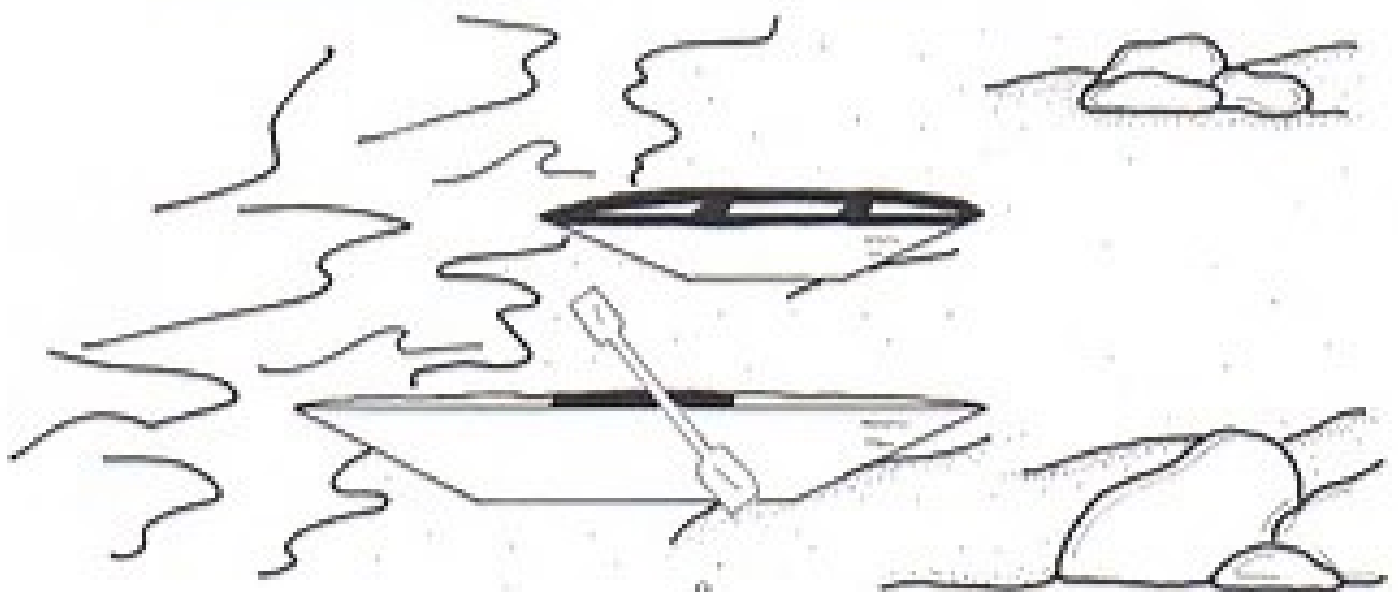

# O PEIXINHO

Use um quadrado de papel medindo 10 x 10 cm.  
Você pode fazer peixinhos coloridos usando retalhos  
de papel de presente ou folhas de revistas.

Corte nas partes indicadas.

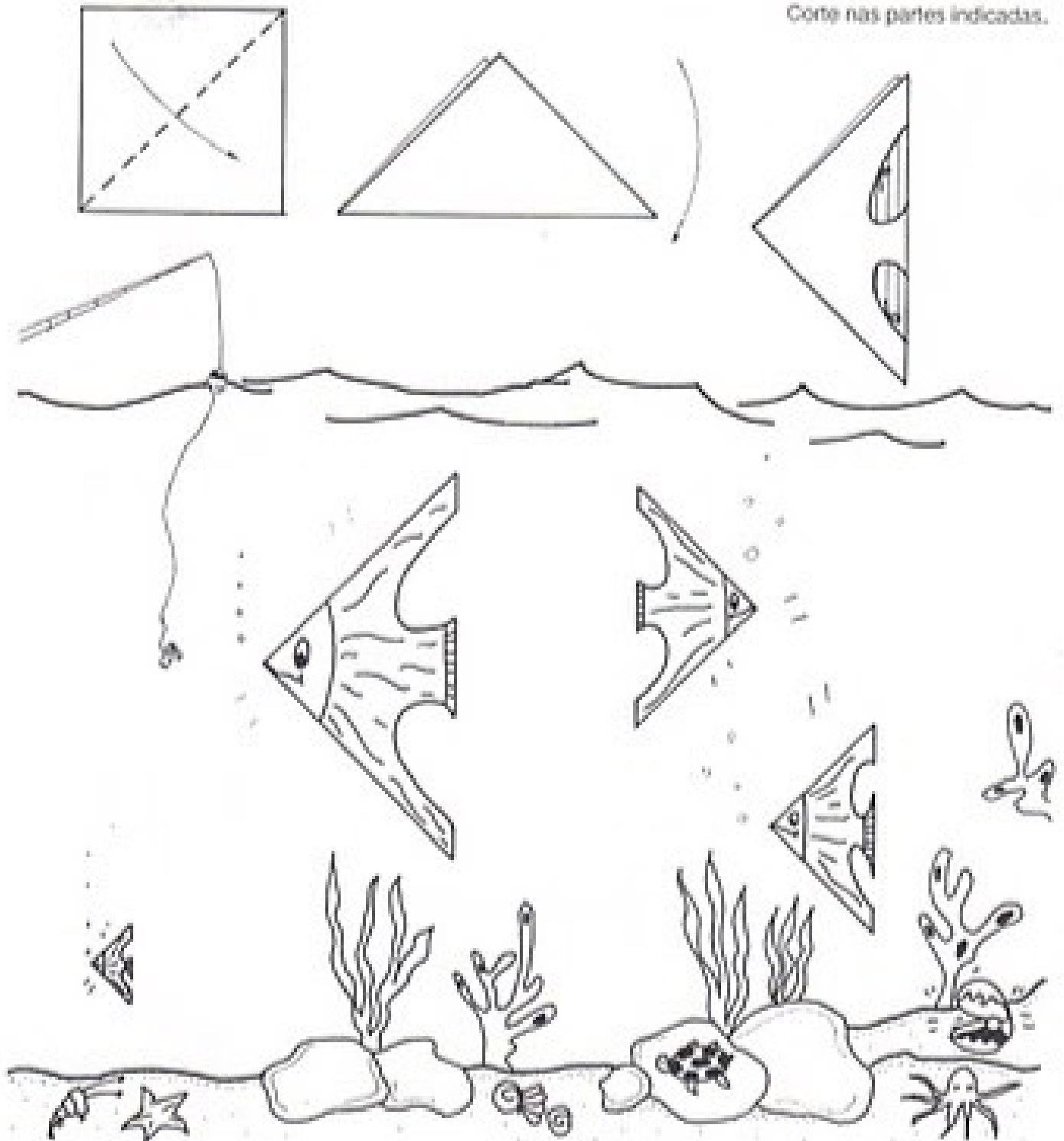



# A GAIVOTA QUE VOA

Use um quadrado de papel espelho medindo 16 x 16 cm.



Peguei o chapéu e fui passear na praia.



O vento demobou o meu chapéu no chão e ele ficou com a ponta amassada.

Dobrei o chapéu ao meio e acenei para uma gaivota que passava.

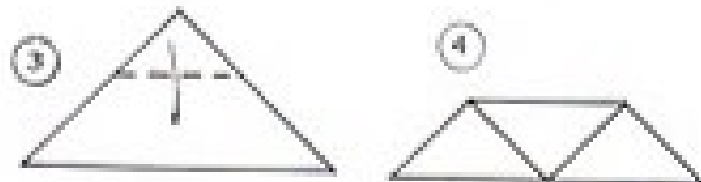
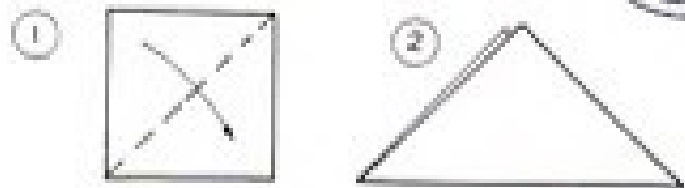

Puxe

Para fazer a gaivota voar, puxe a aba indicada para baixo. Enquanto isso, segure com firmeza a frente da figura.

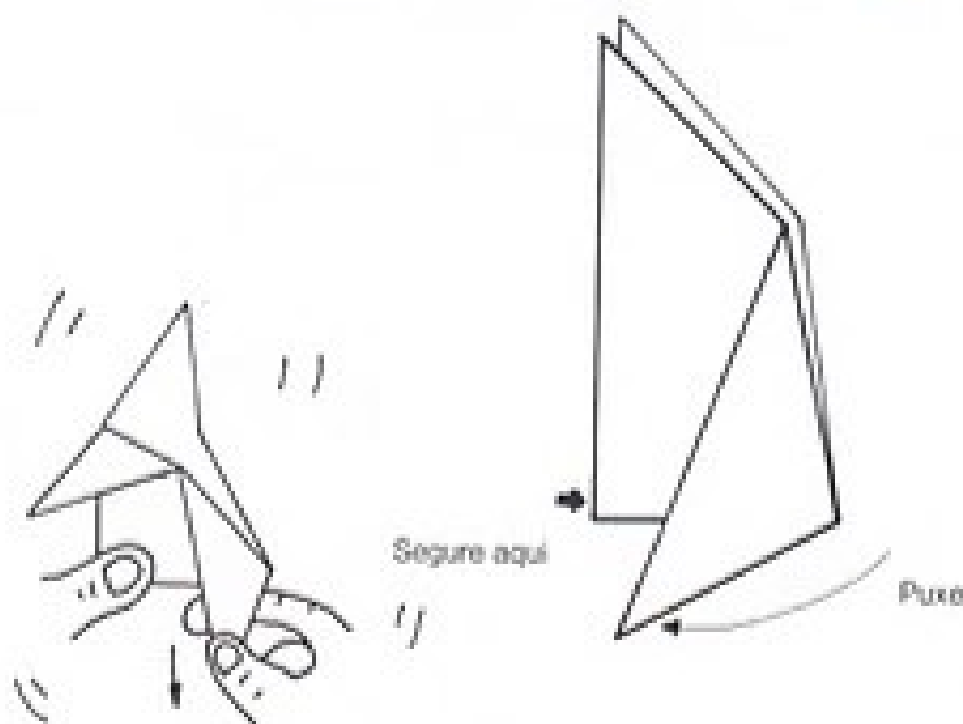

# O PEIXE

Use um quadrado de papel espelho medindo 16 x 16 cm.

Repita os passos de 1 a 7 da gaivota que voa e siga as instruções a seguir.

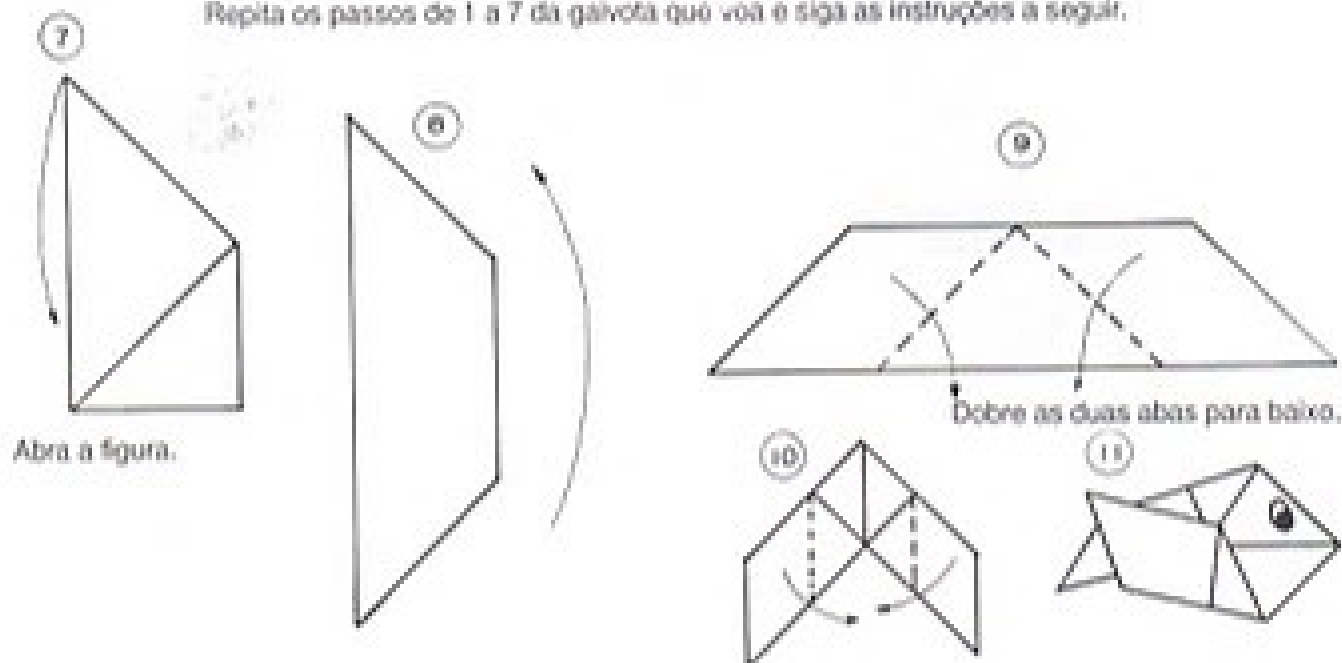

Abra a figura.

Dobre as duas abas para baixo.

Dobre nas linhas indicadas, cruzando as abas. Pinte o olho do peixe.

Você pode utilizar os dois lados da figura para fazer o peixe, obtendo assim dois modelos diferentes.

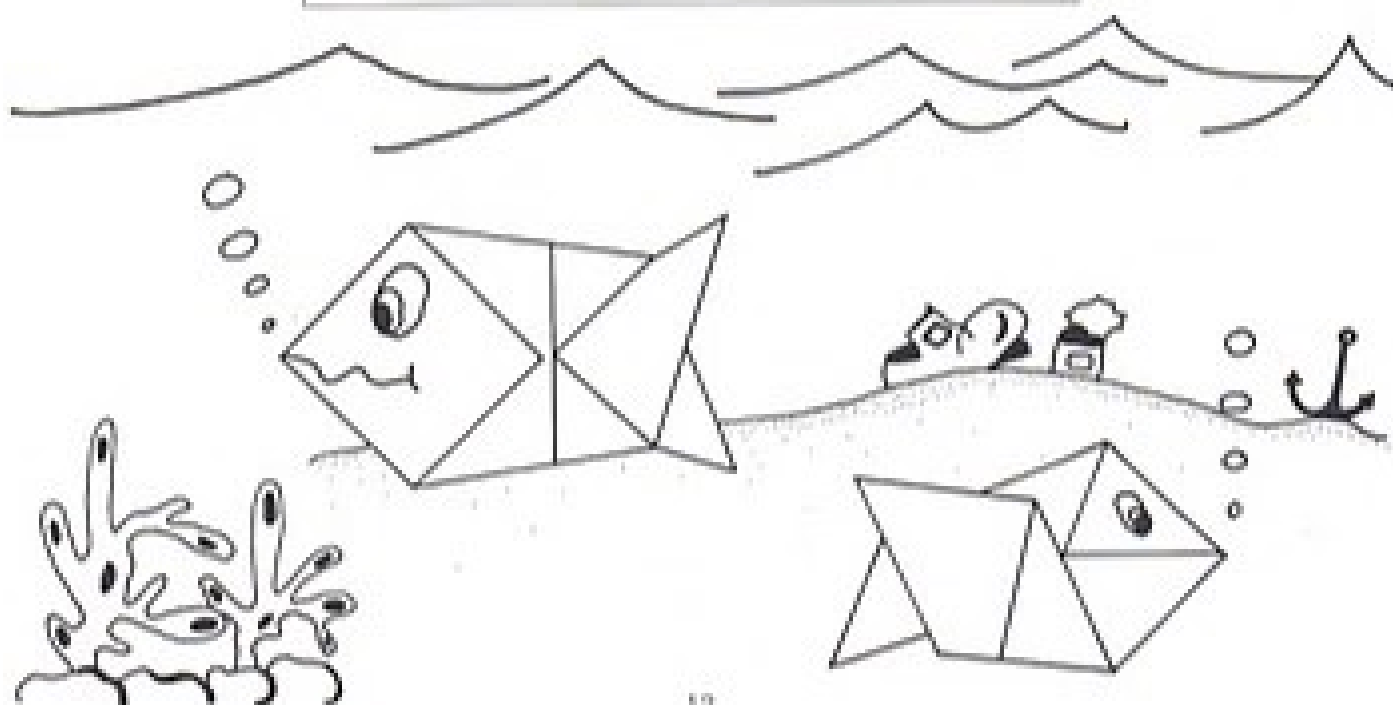

# A BALEIA

Use um quadrado de papel espelho medindo 16 x 16 cm.

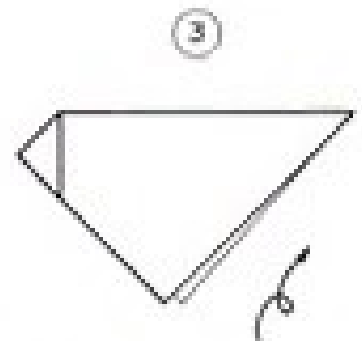
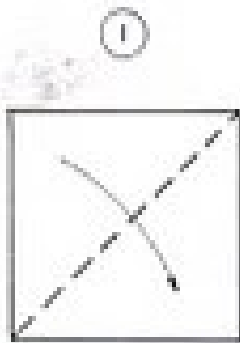

Vire a figura.

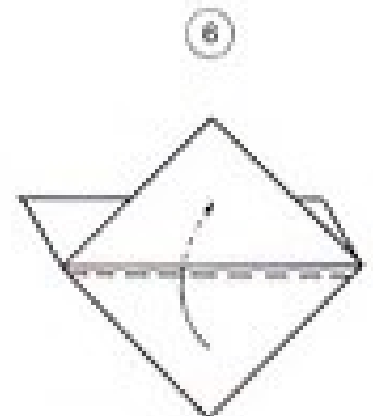
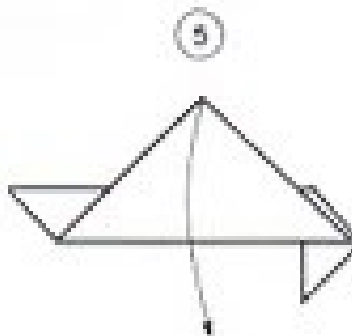
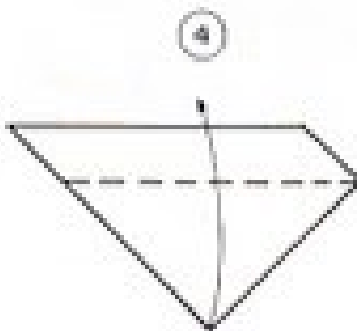

Abaixé a aba da frente.

Coloque a aba dentro do "bolso".

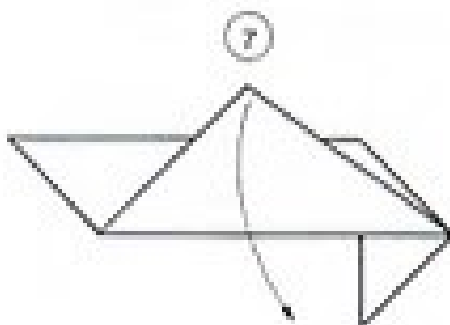

Abaixé a outra aba.

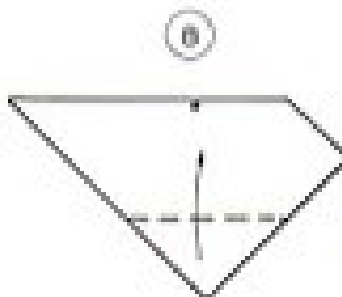

Dobre novamente a aba para cima até o ponto, não deixando-a sair da figura.

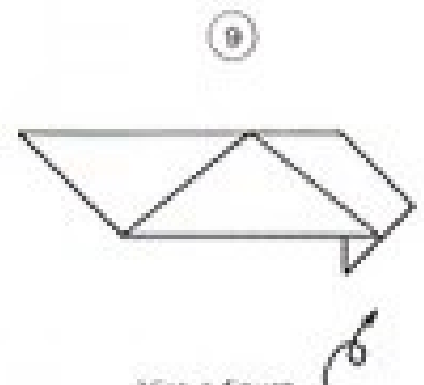

Vire a figura.

10



Dobre essa ponta para dentro.

11

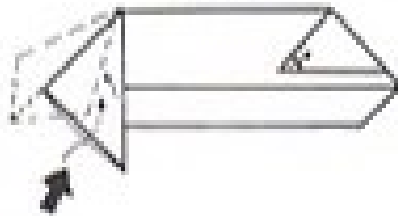

Abra um caput.

12

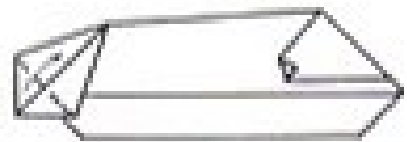

Dobre essa ponta para cima.

Dobre para trás para formar a cauda da baleia.

13

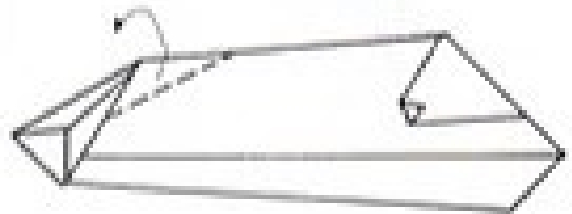

Dobre para trás para arredondar a cabeça e pintar o olho da baleia.

14

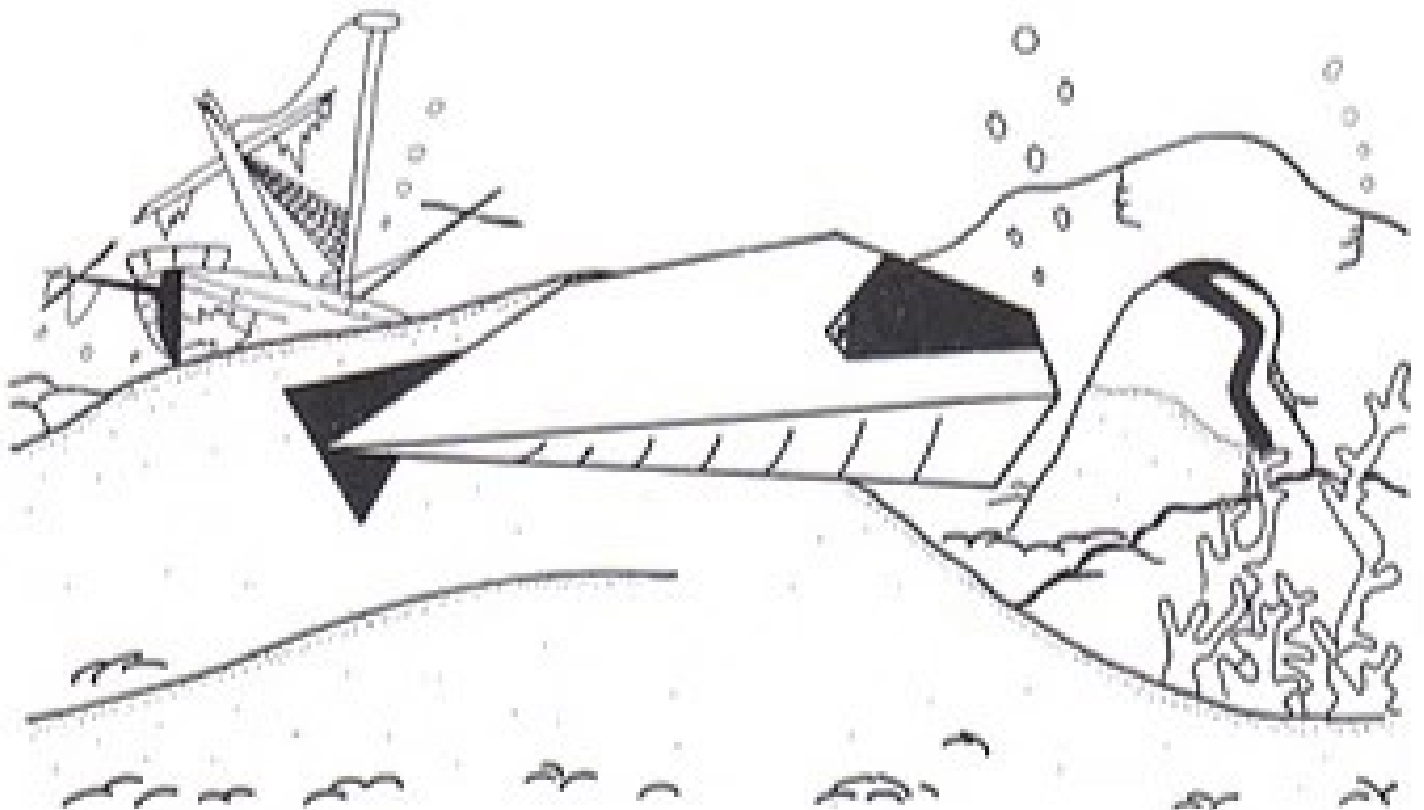
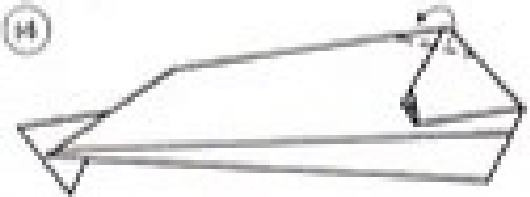

# O TUBARÃO

Use um quadrado de papel espelho medindo 16 x 16 cm.

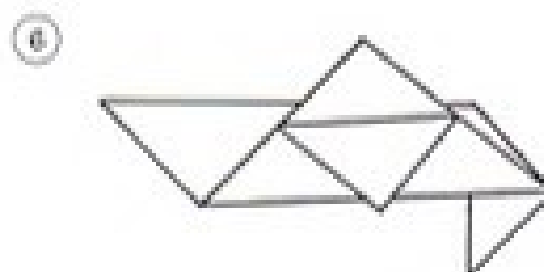
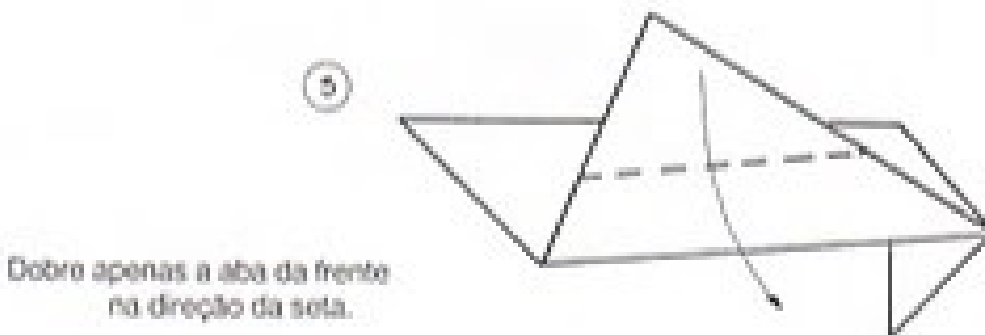
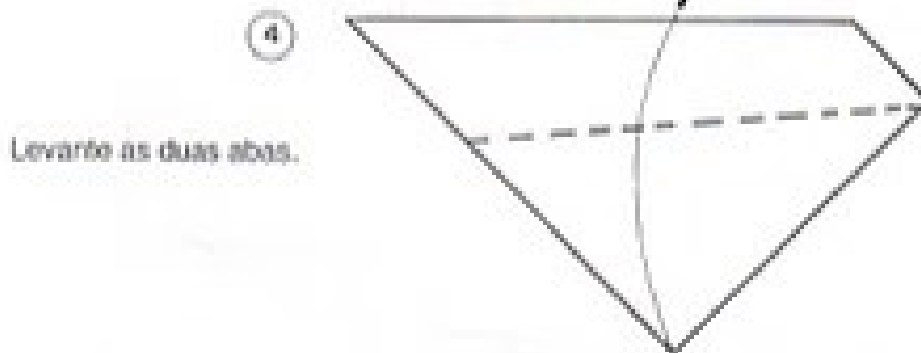
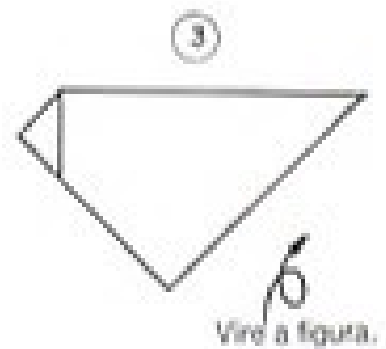
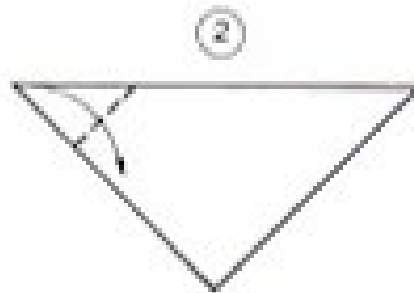
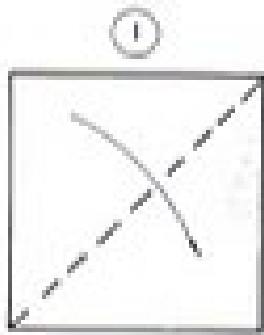

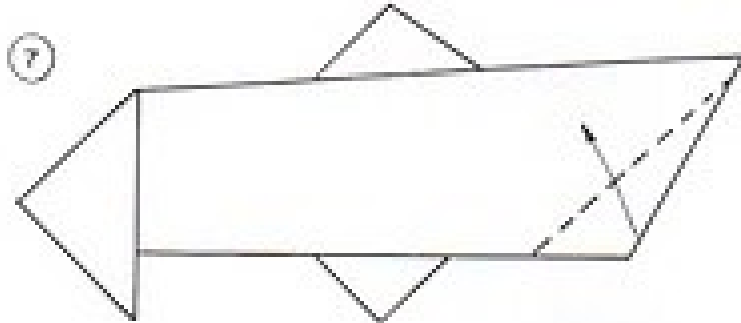

Levante essa ponta.

Decore o tubarão.

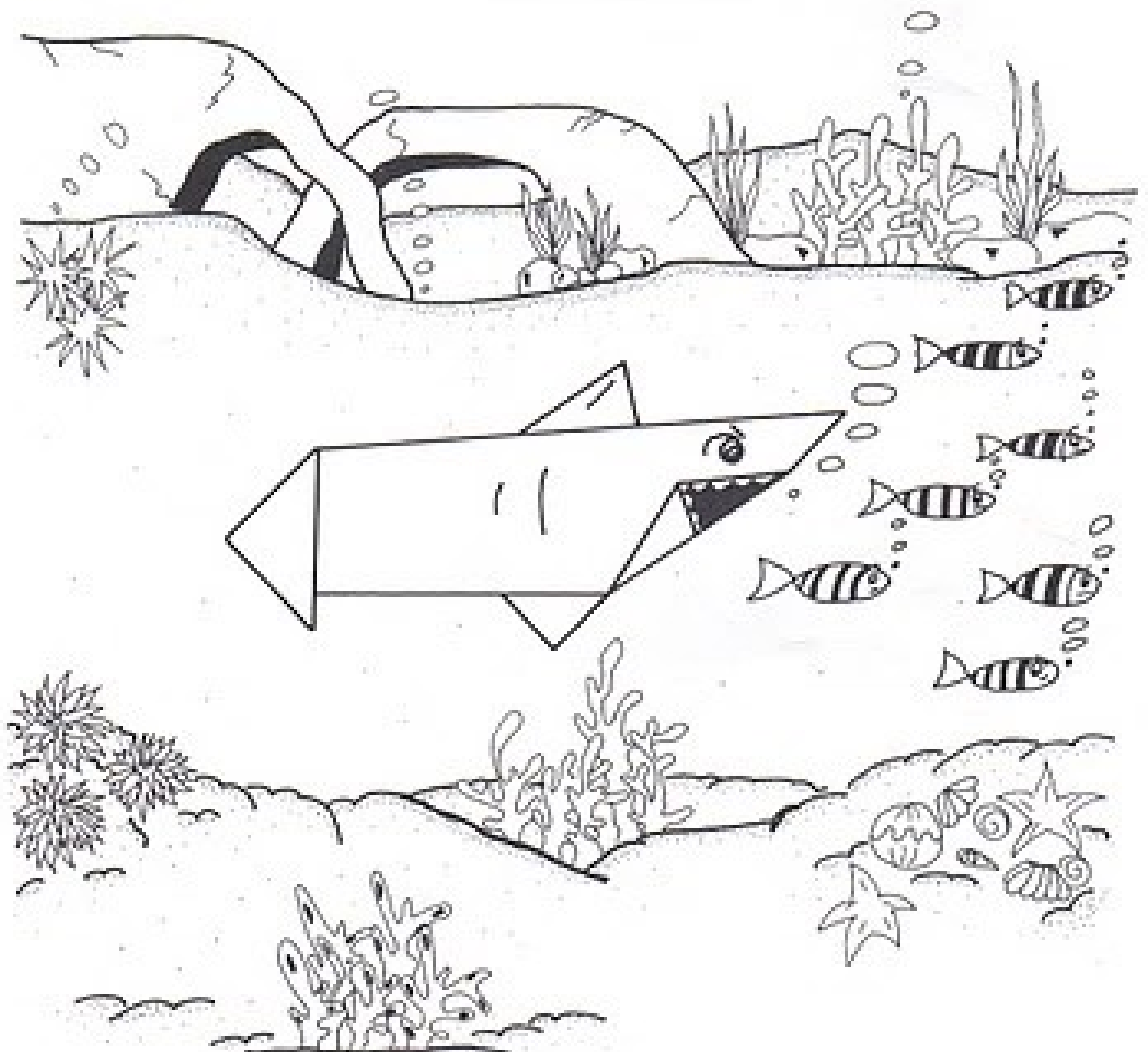

# A TARTARUGA

Use um quadrado de papel espelho medindo 10 x 10 cm para o corpo e um retângulo de papel estampado para o casco.

Transfira o molde do casco para o papel estampado e recorte.

MOLDE DO CASCO



Peguei o meu chapéu, coloquei-o na cabeça e fui passear.



Encontrei uma borboleta que pousou no meu chapéu. Levantei os braços para espantá-la.

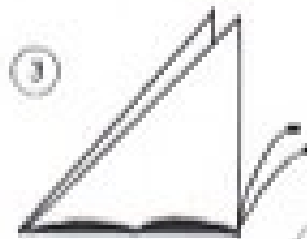
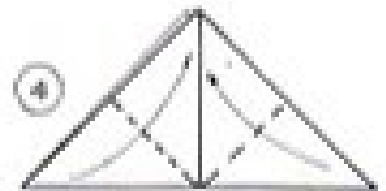
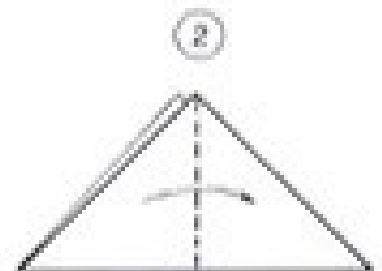

Abaixei as mãos e dei um abraço na borboleta.

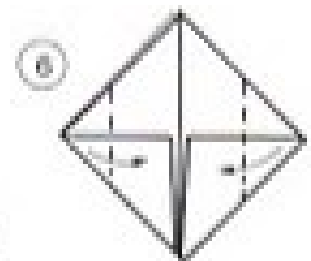
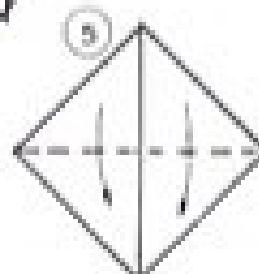

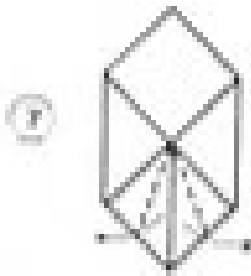

Dobre as duas abas para fora.

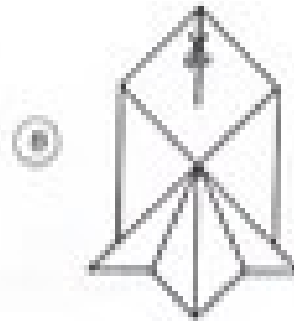

Corte somente a folha de cima até o meio.

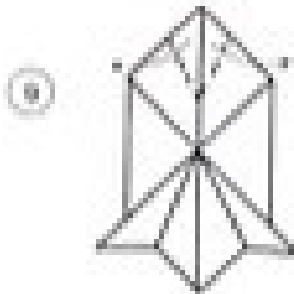

Dobre as duas abas para fora.

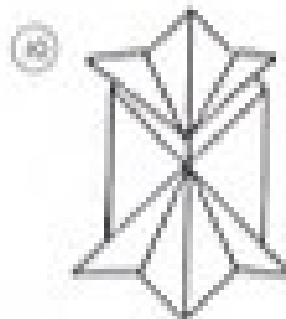

Vire a figura e cole o casco por cima.

Pinte os olhos e decore o casco da tartaruga.

