

GLÁUCIA LOMBARDI

A Praia

Brincando com dobradura

5ª Edição

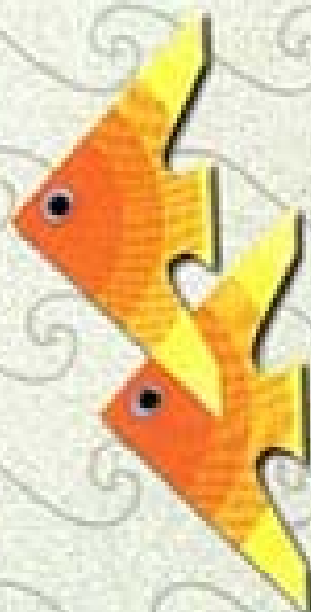
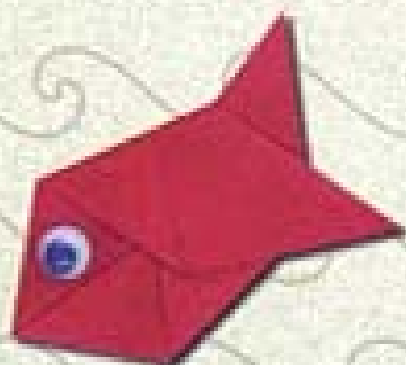
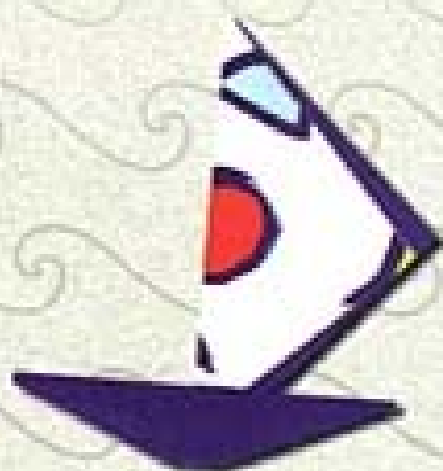
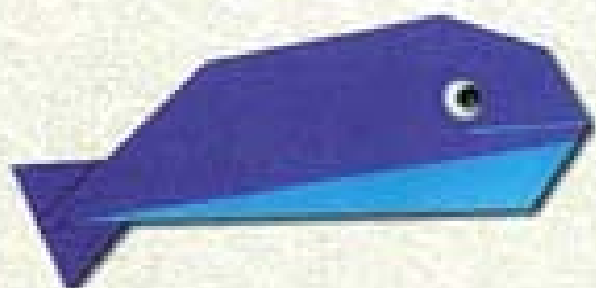

PALILUS

A PRAIA

O SORVETE E A PIPA

Use um papel quadrado medindo 10 x 10 cm.

Acompanhe a história e preste atenção aos movimentos correspondentes.

Peguei um papel quadrado, dobrei-o ao meio, transformando-o em um chapéu triangular.

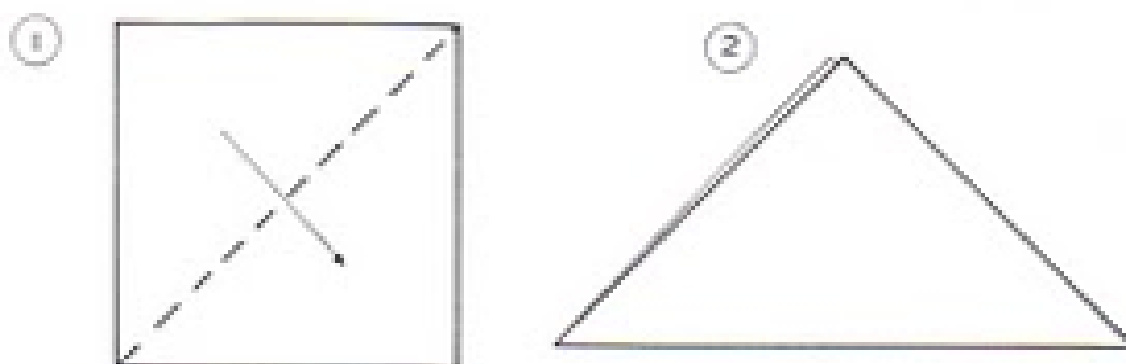

Estava muito calor e eu usei o papel para me abanar. Fui tomar sorvete de casquinha.

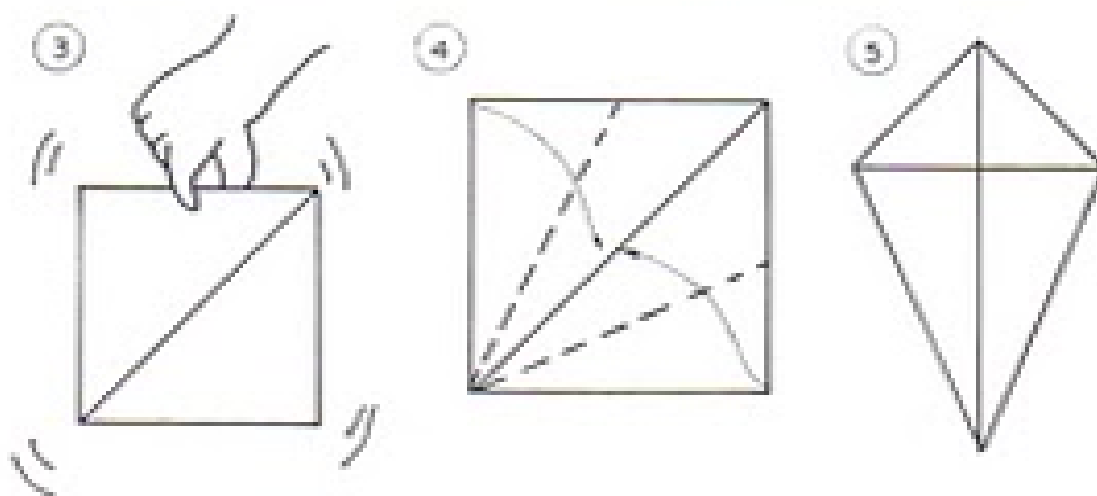

Para o sorvete ficar mais gostoso, a parte de cima dele pode ser recortada. Você também pode fazer uma colagem com algodão e papel colorido.

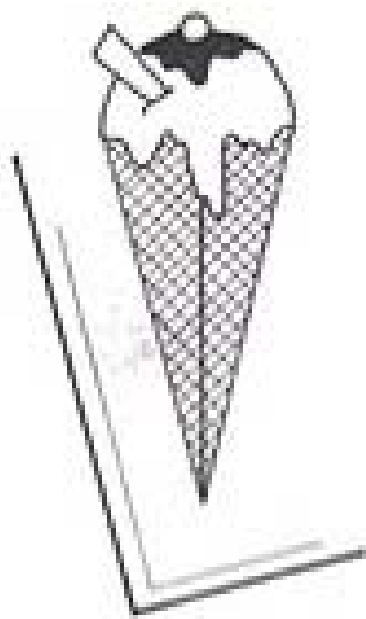

Quando virei o sorvete ele se transformou em uma pipa.
Fui seguindo a pipa que rodopiava no ar, até que cheguei a uma praia.

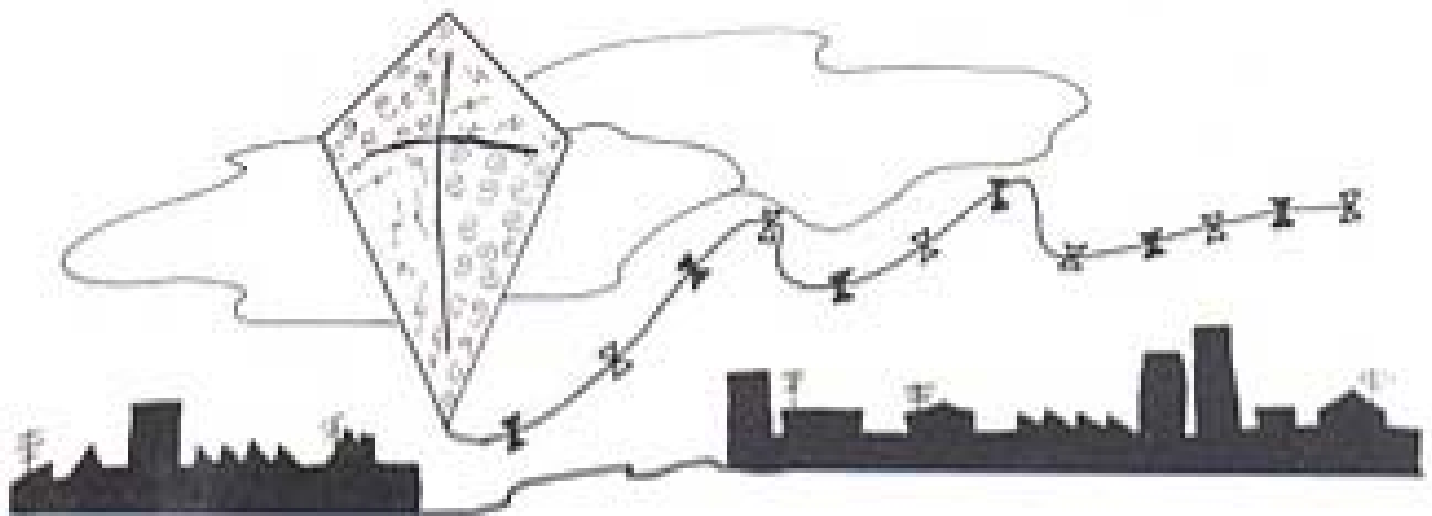

E que bela vista eu encontrei:

- alguns barquinhos navegando
- um caranguejo solitário andando sobre a areia
- crianças brincando de veleiro e caiaque
- muitos peixinhos coloridos
- uma gaivota voando perto do mar
- uma baleia e um tubarão
- uma tartaruga marinha pondo seus ovos na areia
- e os turistas se divertindo debaixo do guarda-sol.

O BARCO

Use um papel quadrado medindo 10 x 10 cm.

Peguei um chapéu e fui passear na praia.

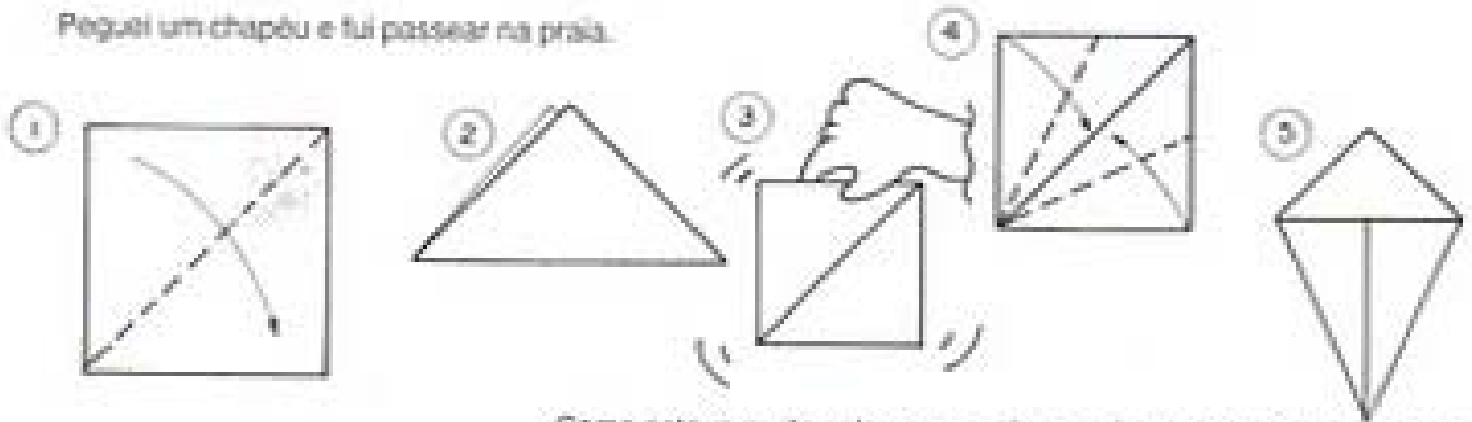

Como estava muito calor, comecei a me abanar e fui tomar um sorvete.

Por causa do calor, a copa do meu sorvete derreteu injirinha.

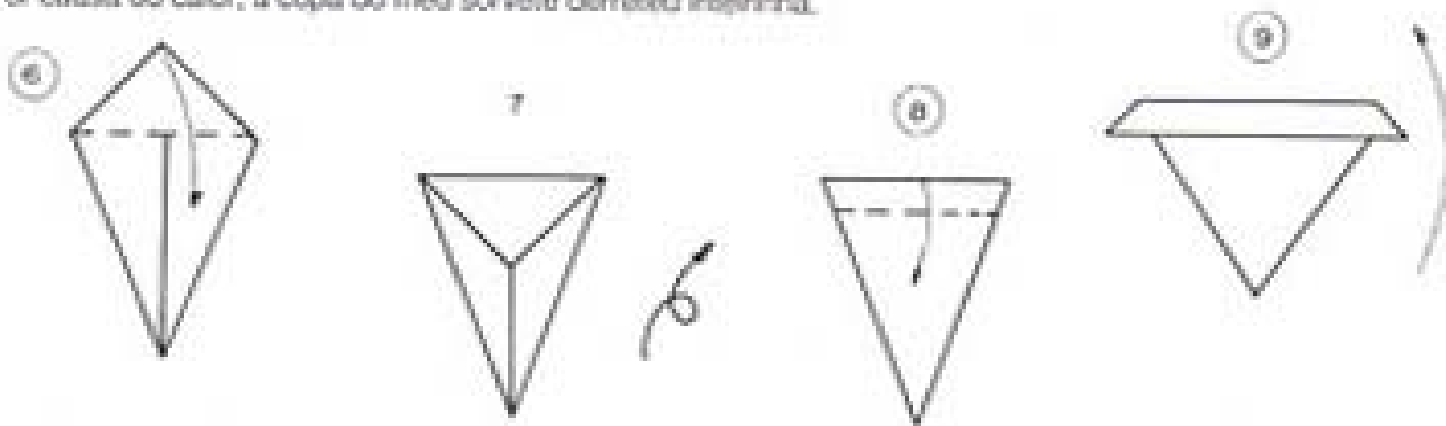

Eu virei o sorvete, mas ele continuou derretendo.

Lá longe eu vi um barco.

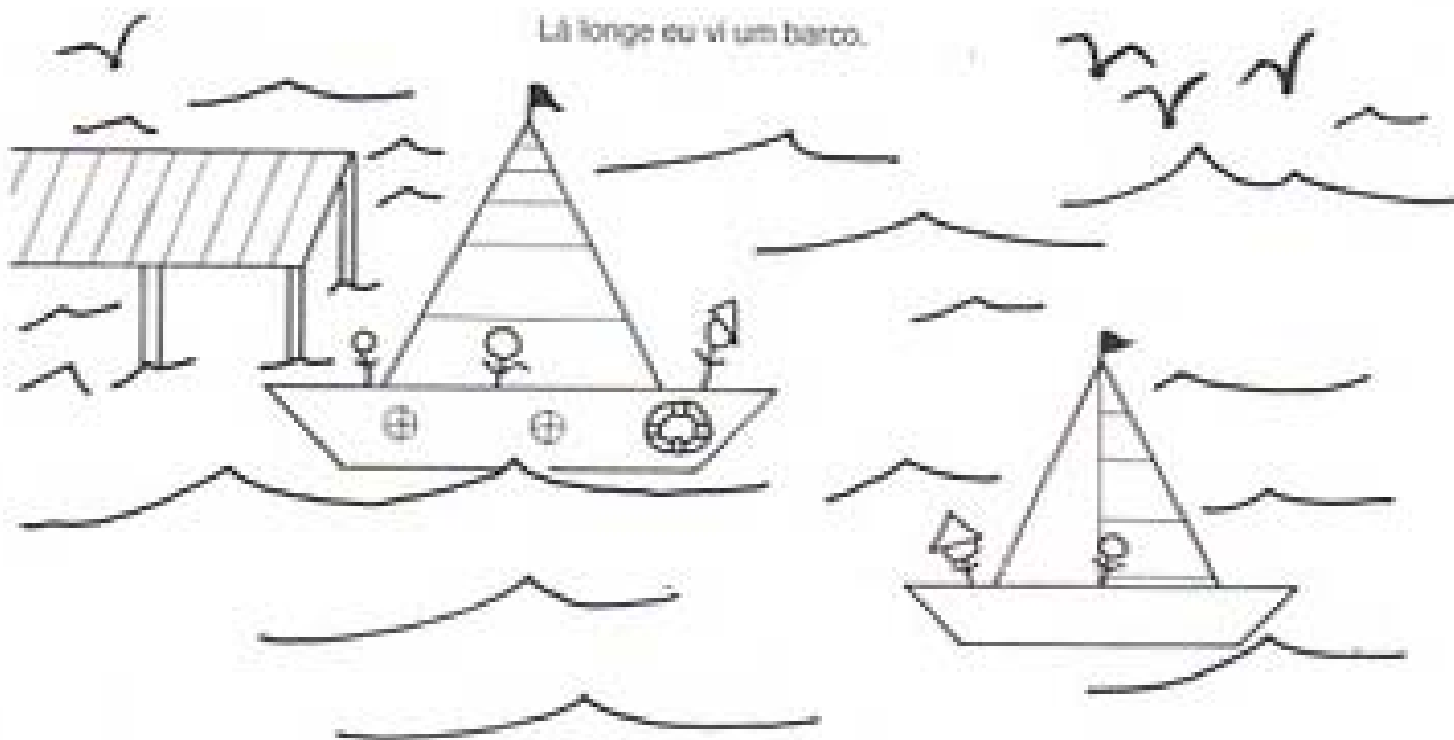

O CARANGUEJO

Use dois quadrados de papel espelho medindo 10 x 10 cm.
Dobre os dois quadrados da mesma maneira, seguindo as instruções de 1 a 8.

Peguei o meu chapéu e fui tomar sorvete na praia.

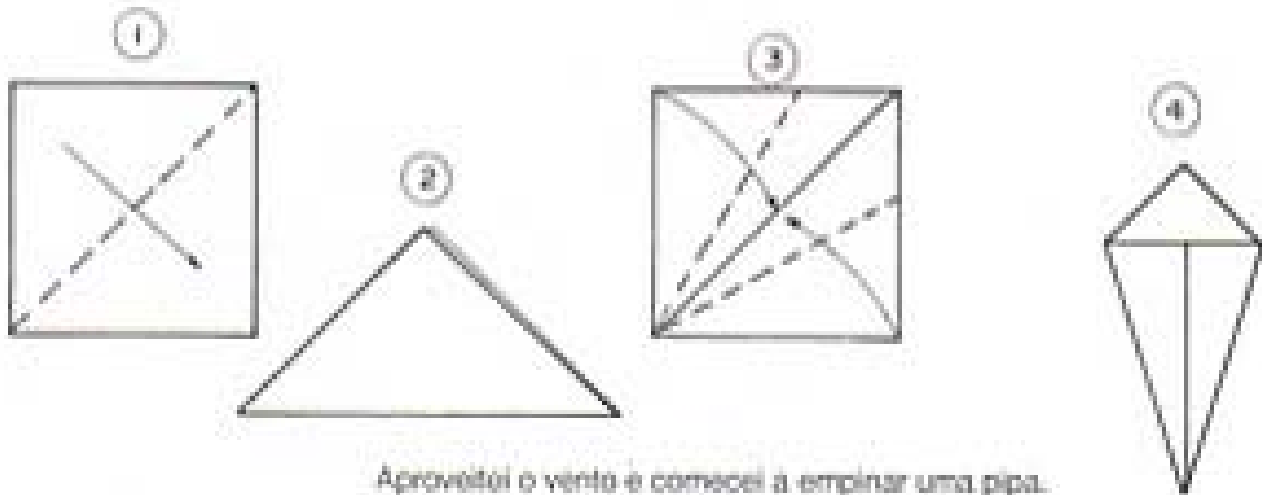

Aproveitei o vento e comecei a empinar uma pipa.

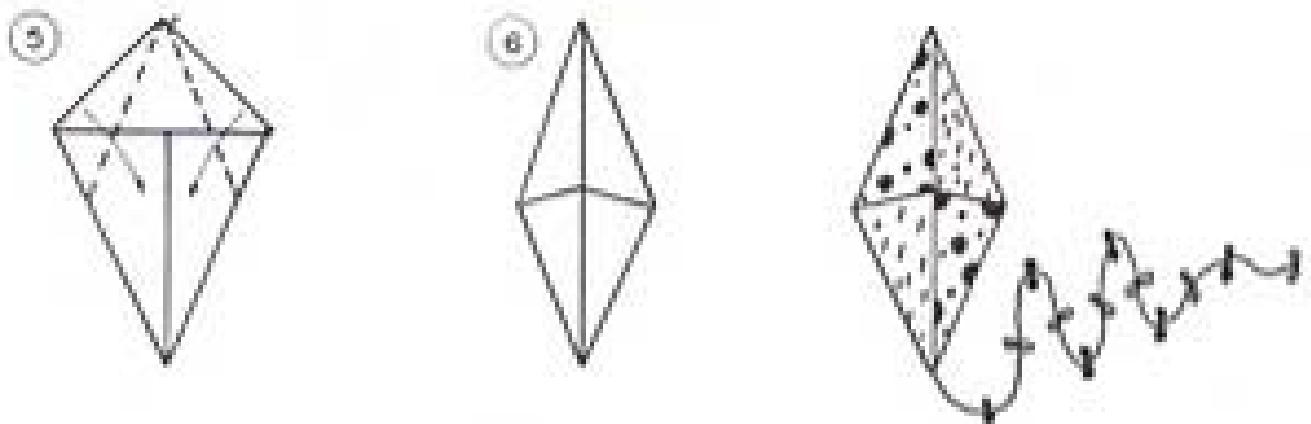

Ela voou e se enroscou em uma árvore. Eu puxei a linha e a pipa dobrou ao meio.

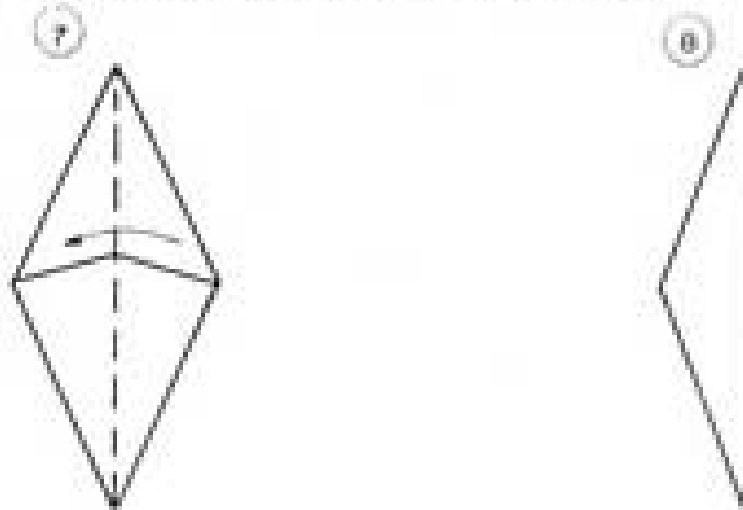

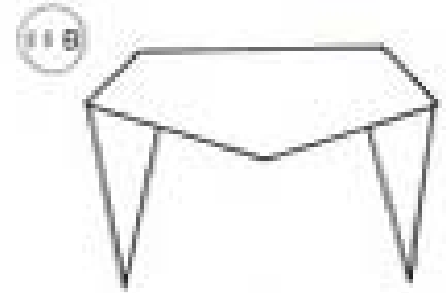
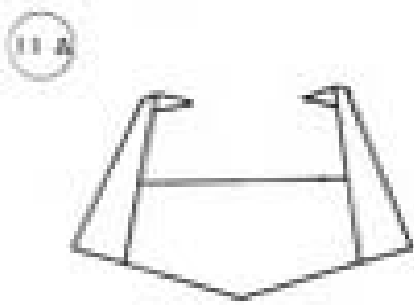
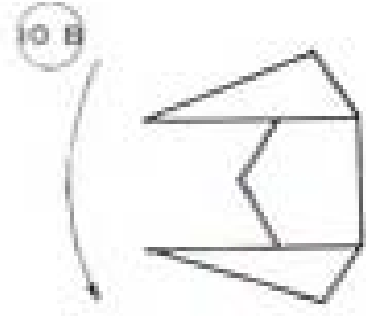
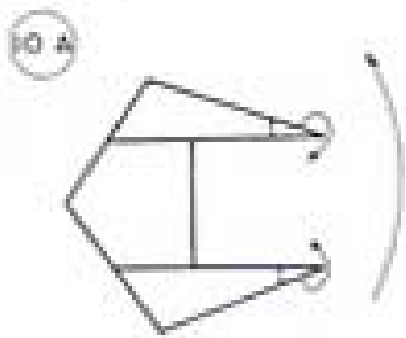
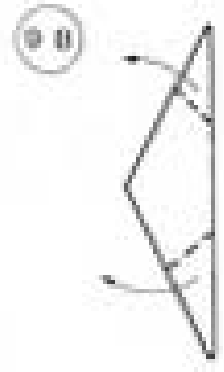
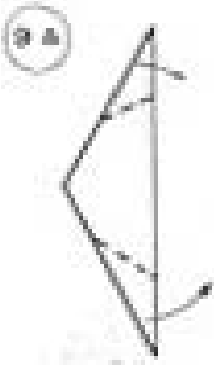

Coloque a figura A sobre a figura B.

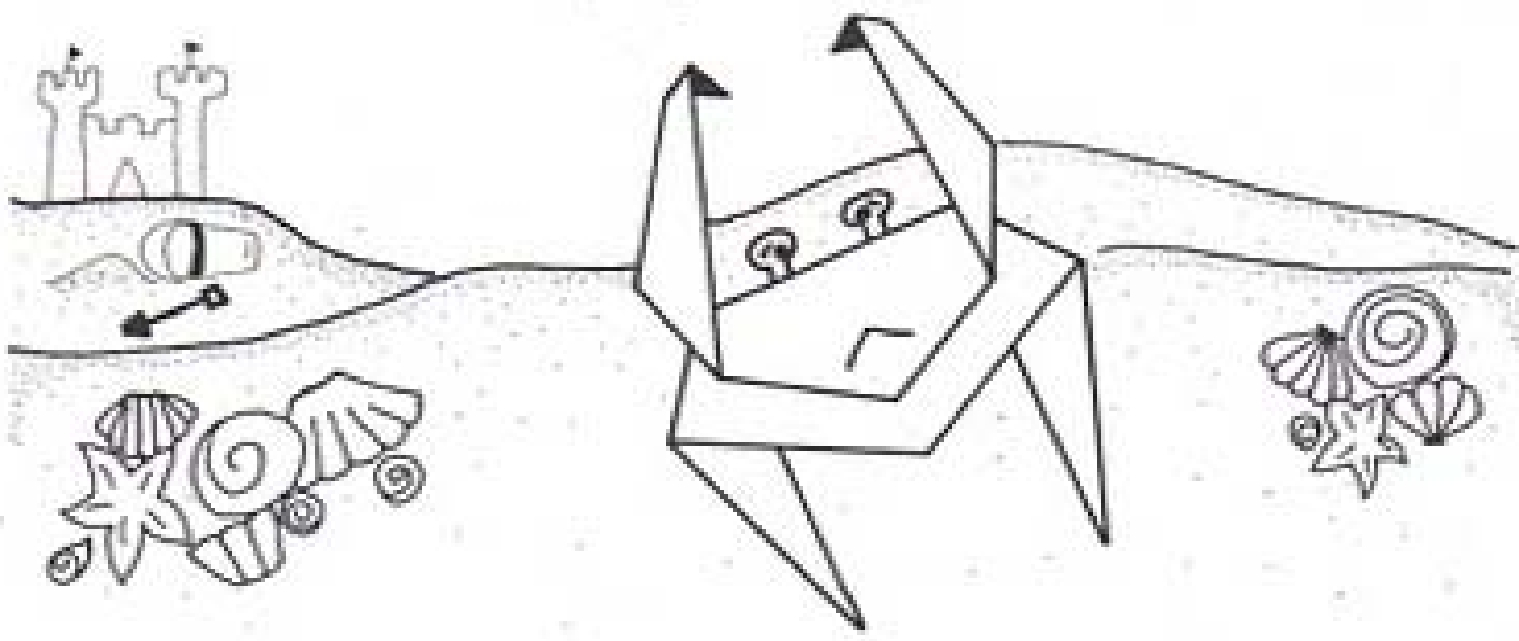

O VELEIRO E O CAIAQUE

Use dois quadrados de papel espelho medindo 10 x 10 cm.

Em um dos quadrados, repita os passos de 1 a 6 do caranguejo.

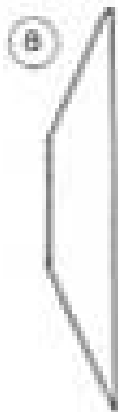
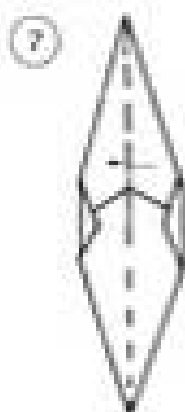
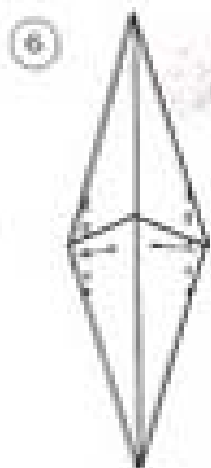

Faça um chapéu no segundo quadrado.

Junte as figuras para formar o veleiro.



Use apenas a parte de baixo do veleiro para fazer um caiaque ou uma canoa.

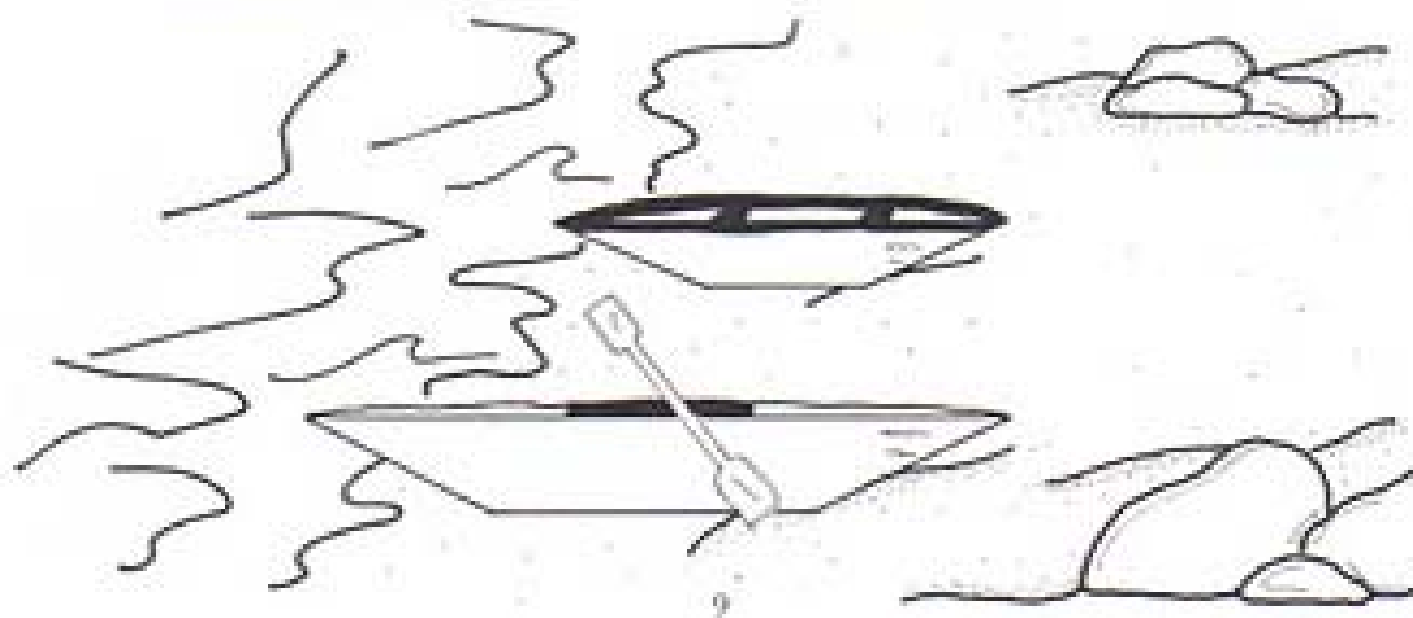

O PEIXINHO

Use um quadrado de papel medindo 10 x 10 cm.
Você pode fazer peixinhos coloridos usando retalhos
de papel de presente ou folhas de revistas.

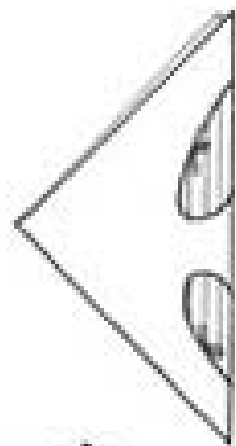

Corte nas partes indicadas.

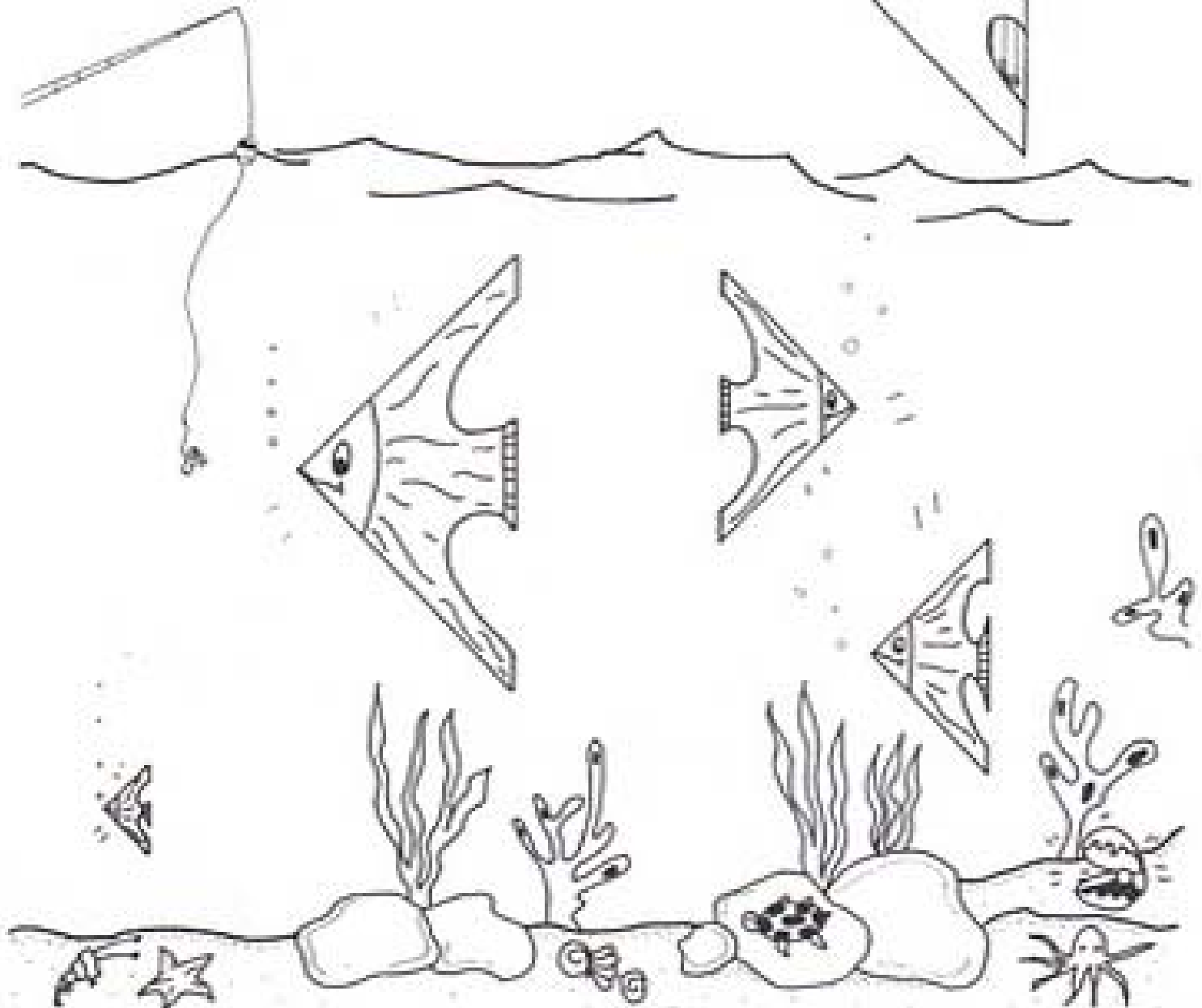

A GAIVOTA QUE VOA

Use um quadrado de papel espelho medindo 16 x 16 cm.



Peguei o chapéu e fui passear na praia.



O vento demorou e meu chapéu no chão e ele ficou com a ponta amassada.

Dobrei o chapéu ao meio e acenei para uma gaivota que passava.

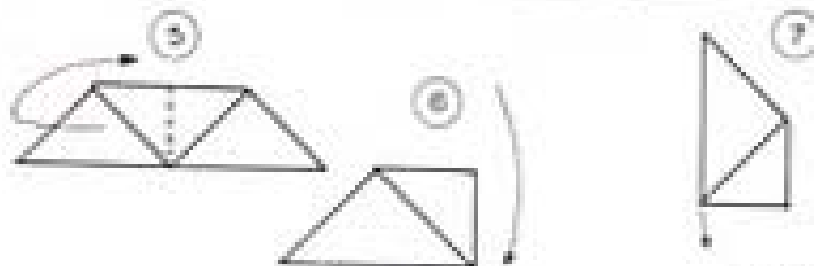
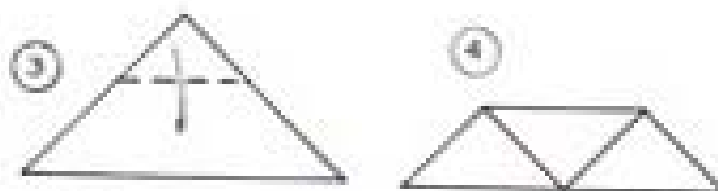
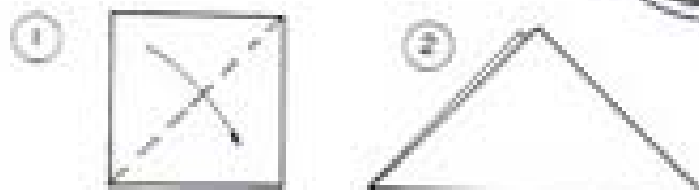

Puxe

Para fazer a gaivota voar, puxe a aba indicada para baixo. Enquanto isso, segure com firmeza a frente da figura.

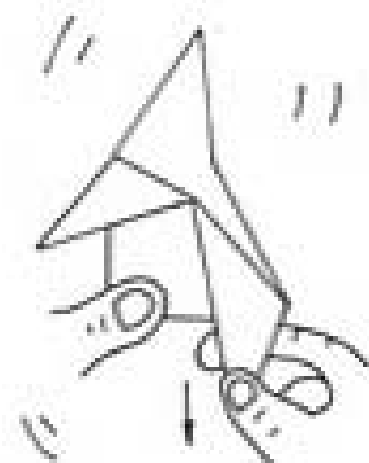

Segure aqui



Puxe

O PEIXE

Use um quadrado de papel espelho medindo 16 x 16 cm.

Repita os passos de 1 a 7 da gaivota que voa e siga as instruções a seguir.

7



Abra a figura.

8

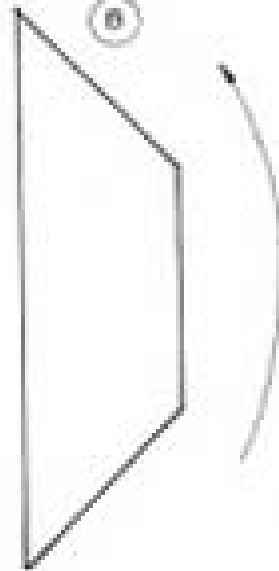

9

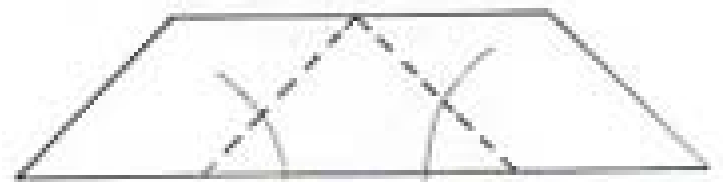

Dobre as duas abas para baixo.

10

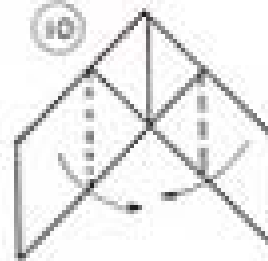

11

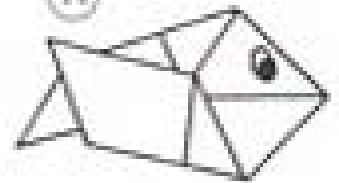

Dobre nas linhas indicadas, cruzando as abas. Pinte o olho do peixe.

Você pode utilizar os dois lados da figura para fazer o peixe, obtendo assim dois modelos diferentes.

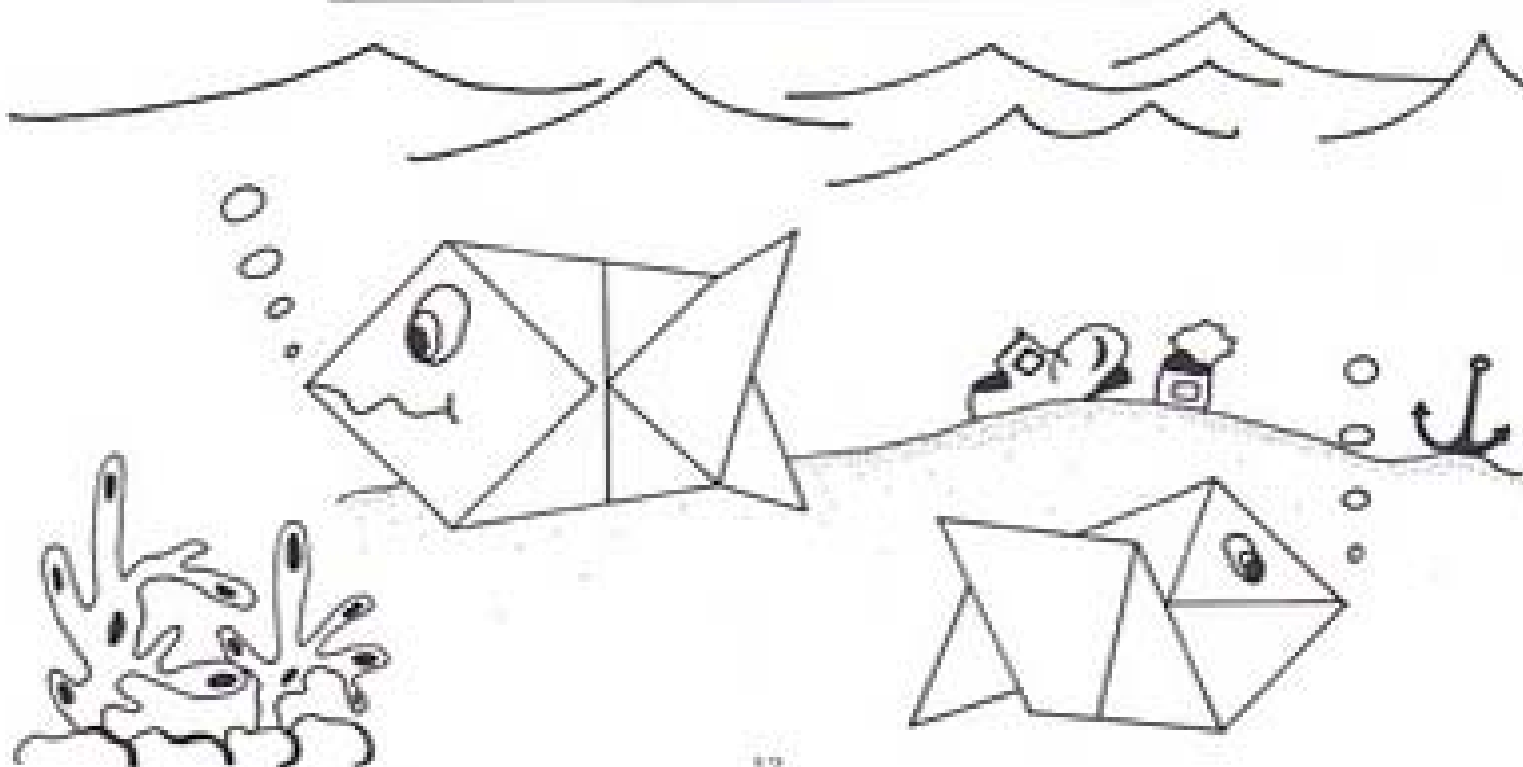

A BALEIA

Use um quadrado de papel espelho medindo 16 x 16 cm.

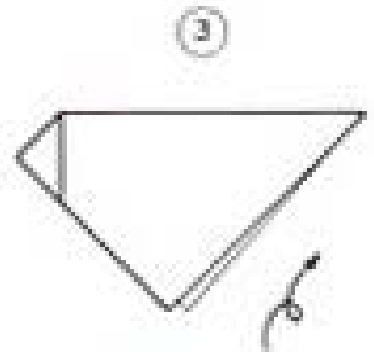
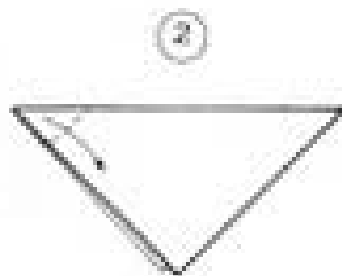

Vire a figura.

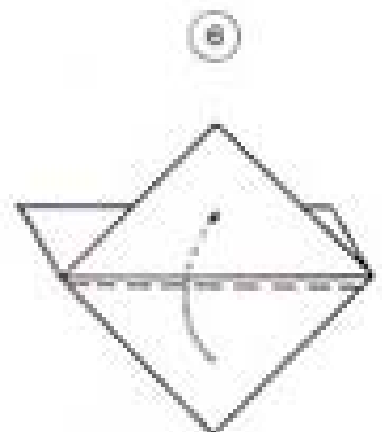
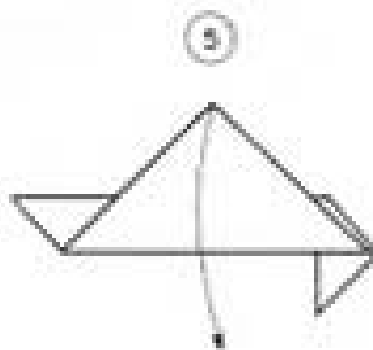
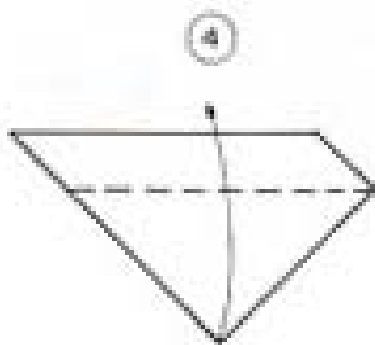

Abaxe a aba da frente.

Coloque a aba dentro do "bolsa".

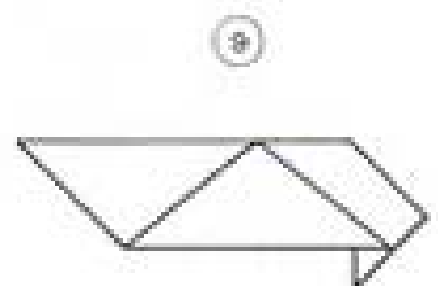
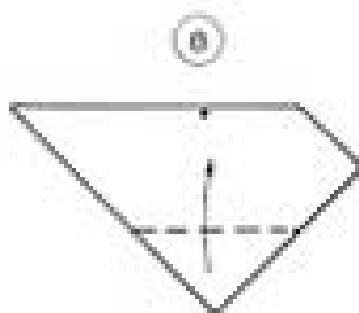
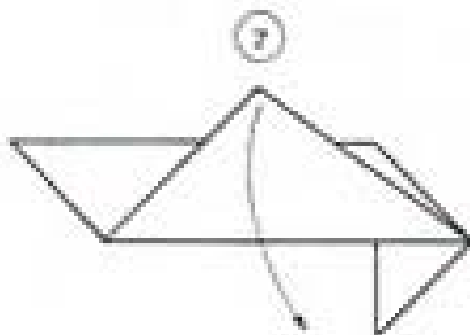

Abaxe a outra aba.

Dobre novamente a aba para cima até o ponto, não deixando-a sair da figura.

Vire a figura.

10

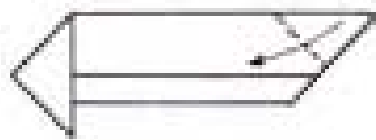

Dobre essa ponta para dentro.

11

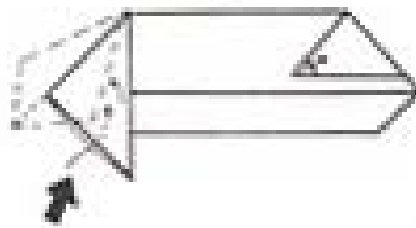

Abra um caput.

12



Dobre essa ponta para cima.

13

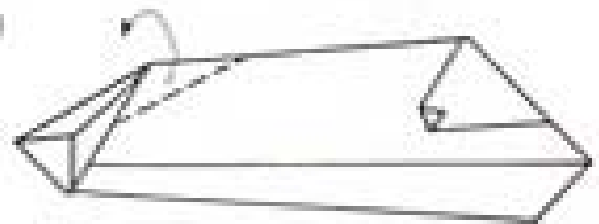

Dobre para trás para formar a cauda da baleia.

14

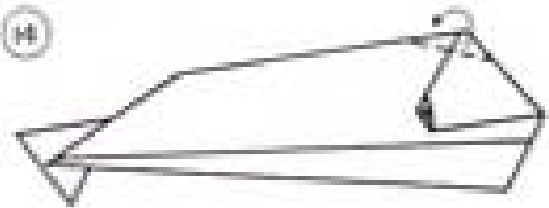

Dobre para trás para arredondar a cabeça e pintar o olho da baleia.

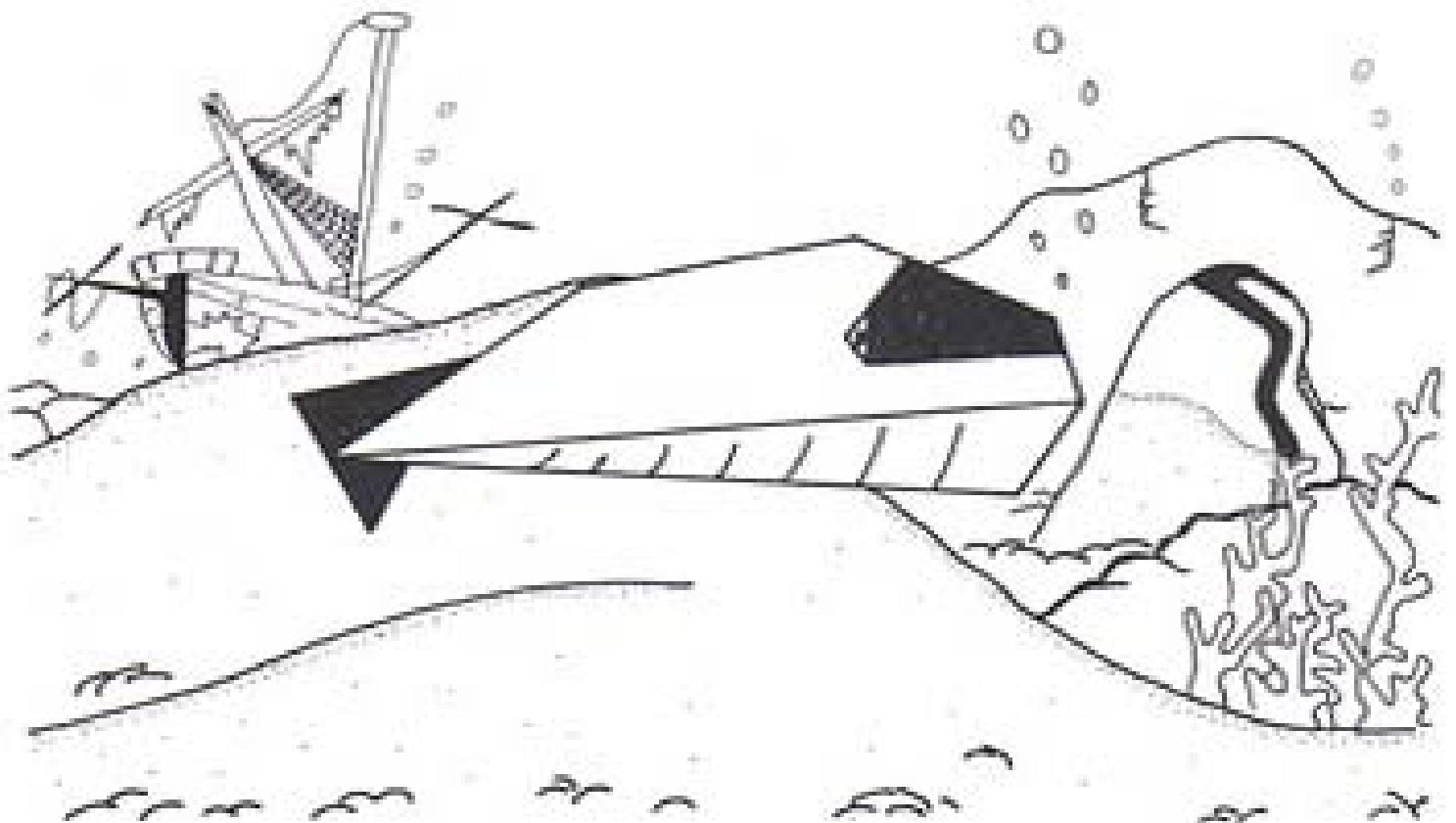

O TUBARÃO

Use um quadrado de papel espelho medindo 16 x 16 cm.

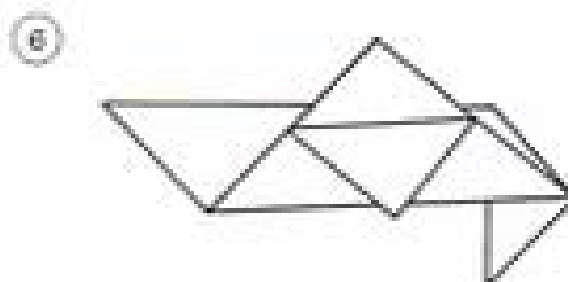
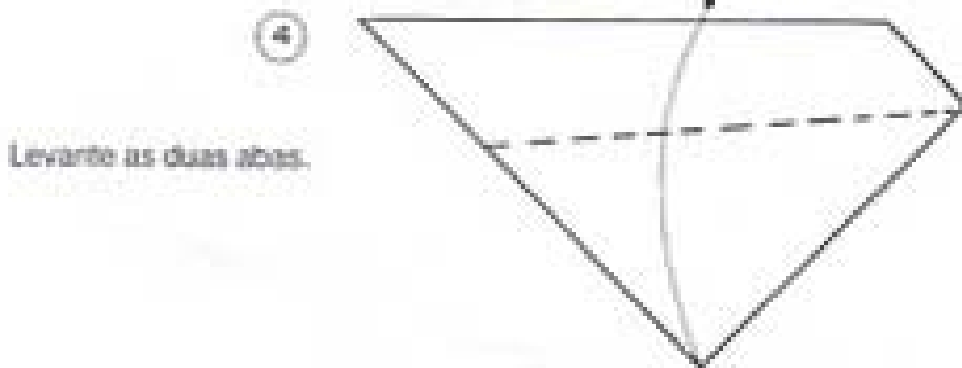
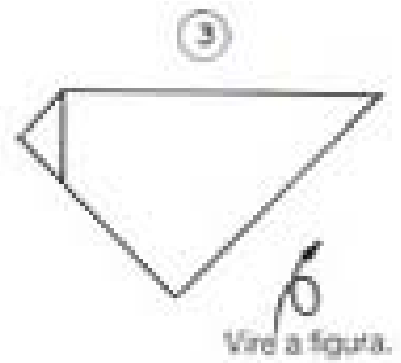
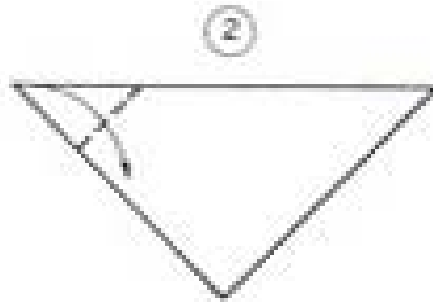
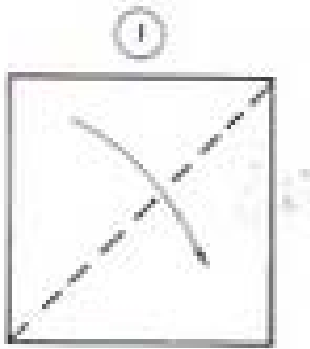

Vire a figura.

7

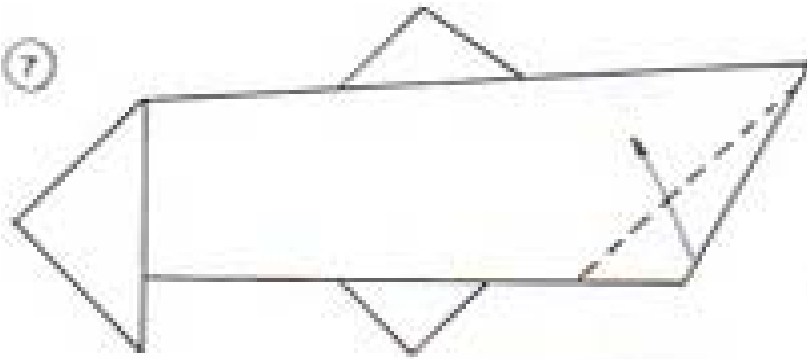

Levante essa porta.

Decore o tubarão.

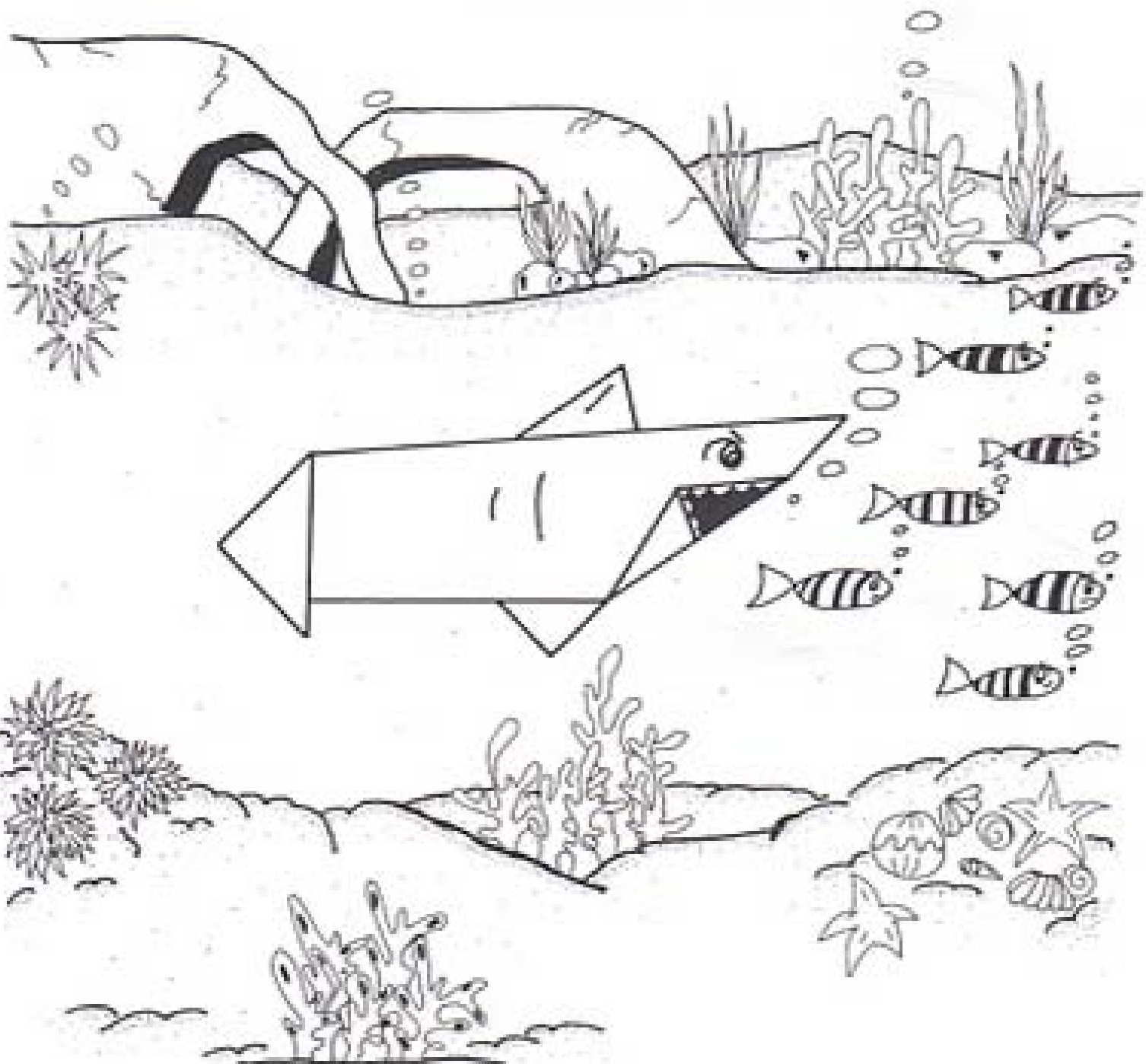

A TARTARUGA

Use um quadrado de papel espelho medindo 10 x 10 cm para o corpo e um retângulo de papel estampado para o casco.

Transfira o molde do casco para o papel estampado e recorte.

MOLDE DO CASCO



Peguei o meu chapéu, coloquei-o na cabeça e fui passear.

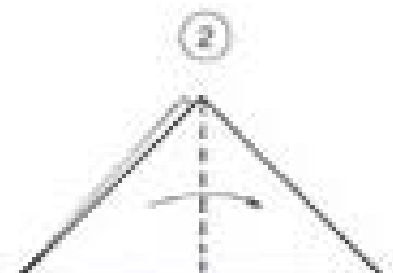

Encontrei uma borboleta que pousou no meu chapéu. Levantei os braços para espantá-la.

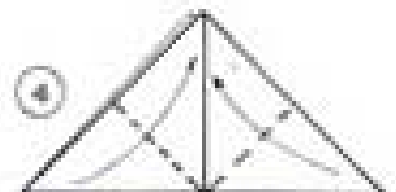

Abaixei as mãos e dei um abraço na borboleta.

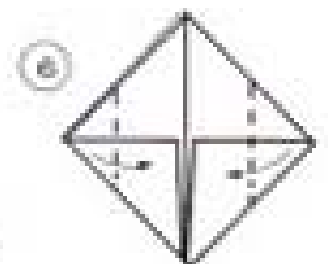
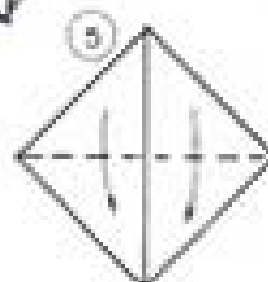

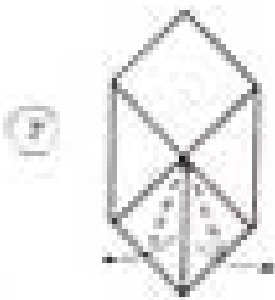

Dobre as duas abas para fora.

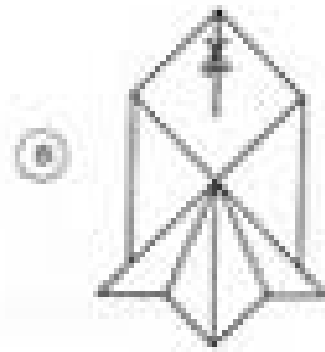

Corte somente a folha de cima até o meio.

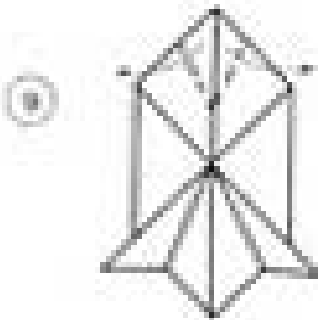

Dobre as duas abas para fora.

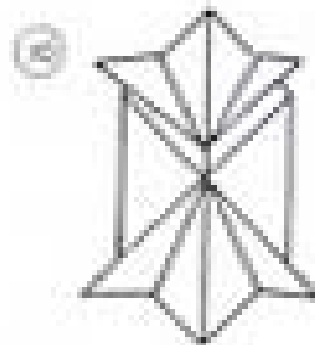

Vire a figura e cole o casco por cima.

Preze os olhos e decore o casco da tartaruga.

